

# Power Test Equipment

## FOR THE GLOBAL POWER INDUSTRY

**T&R Test Equipment** design and manufacture high quality test equipment for the power industry. Our equipment is used world-wide in transmission and distribution, power equipment manufacture, maintenance and commissioning.

It has to do the job first time, every time, so we've designed the units to perform and built them to last.

Our equipment will make your life easier by being uncomplicated to use and versatile in application. The market demands that testing time is cut to a minimum so we have eliminated costly set up times by putting the engineer in control of the equipment. The manually driven controls allow true flexibility with power at your finger tips.

You can be confident in choosing from **T&R Test Equipment's** range of equipment. We take pride in what we do because you do.

## Product Range

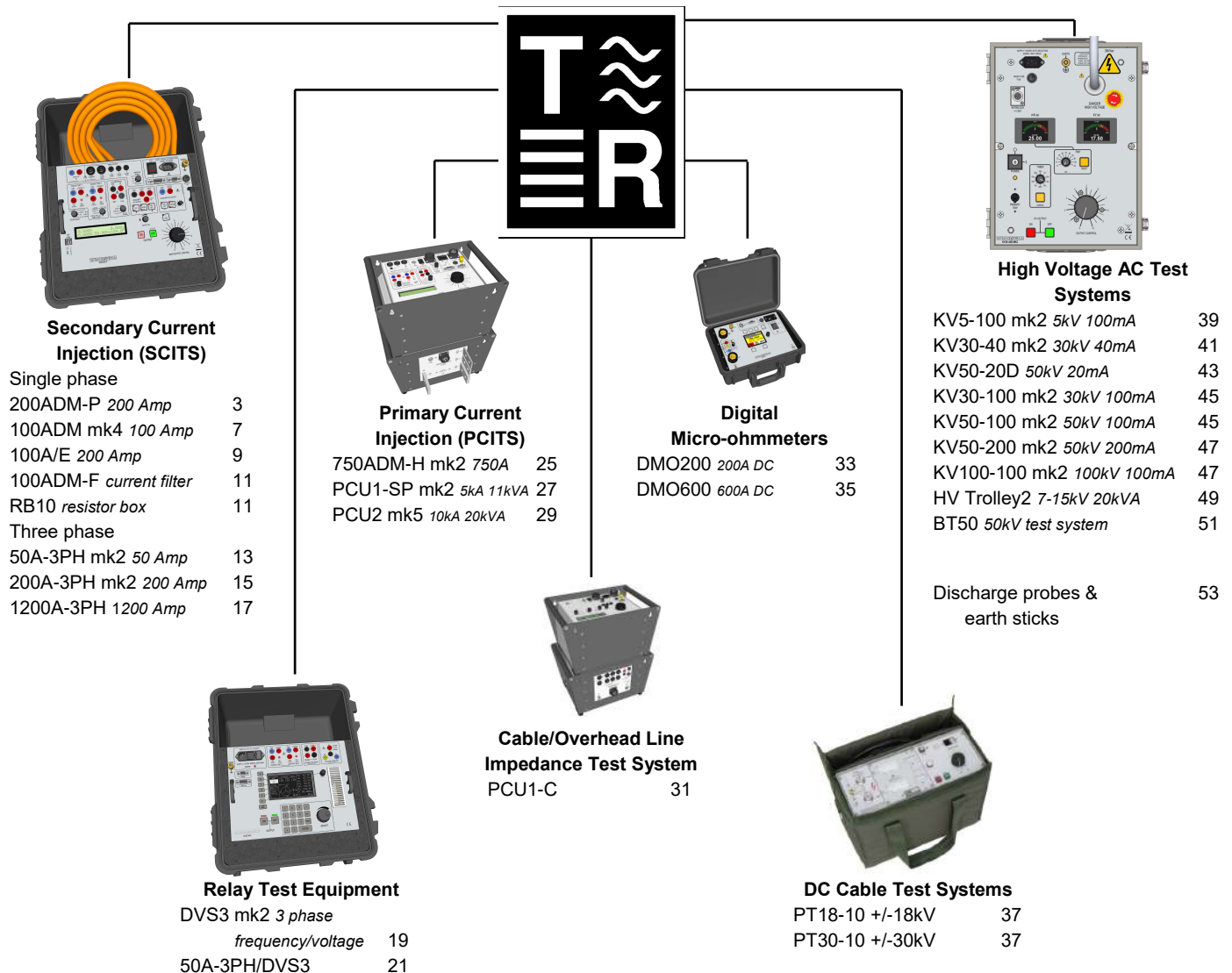

# Product Range

For full technical specification of any product please visit [www.trtest.com](http://www.trtest.com)

## Secondary Current Injection (SCITS)



Our range of units covers applications up to 200A and includes single phase and three phase units for testing and timing of IDMT relays, thermal overloads, MCB's and auto-reclosers, and the 200ADM-P captures data direct to a USB memory stick.

- Over and under current relays
- IDMT relays
- Over and under voltage relays
- Auto-reclosers
- Time delay relays
- Differential relays
- Earth fault relays
- Miniature circuit breakers
- Power relays
- Tripping relays
- Thermal relays
- Voltage regulating relays
- Power relays
- Induction Disk Relays
- Solid State Relays
- Auto-switching dual supply
- RS232 for printer or PC
- Data logging software

## Relay Test Equipment

In addition to the current injection units, we offer systems designed for testing voltage relays, frequency relays, G59 scheme relays, df/dt (ROCOF type), vector surge relays, and AVR types. These can also be used in conjunction with SCITS sets to allow testing of directional relays, power and reverse power relays and distance protection.

- Under and over frequency relays
- Under and over voltage relays
- Synchronising relays
- df/dt & ROCOF relays
- Vector surge relays
- Transducers



## Primary Injection Systems (PCITS)

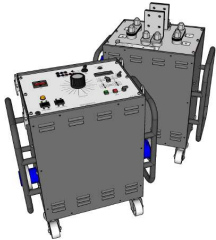

There are several systems available which cover from 750A through to 6000A. Available in single phase, testing applications include testing and timing of under and over current relays, circuit breakers and CT ratio testing.

- Continuously variable output
- Multi-function digital timing system
- Digital true RMS memory ammeter
- Automatic switch-off at end of test
- Loading units from 500A-6000A
- Low impedance, dual-range outputs
- Rugged, compact design
- Secondary injection up to 100A

## Digital Micro-ohmmeters

Our micro-processor controlled range of units offers the testing capability of up to 600 amps DC with 0.1 $\mu\Omega$  resolution. Auto-ranging metering simultaneously displays all three parameters (mV, A, and  $\mu\Omega$ ). Data logging software is also available.

- 0-200/600A DC Test Current
- 0.1 $\mu\Omega$  resolution
- mV, A, and  $\mu\Omega$  displayed simultaneously
- Direct Ohms reading at any current
- Large back-lit liquid crystal display
- Thermal and over-current protection
- Compact and portable
- Auto-switching dual supply voltage
- RS232 interface for printer or PC



## High Voltage AC Test Systems

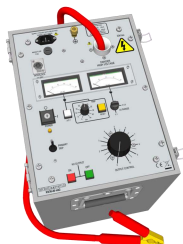

The range of units cover from 5kVac to 100kVAC. All units have a variable trip range setting and key lock operation to prevent unauthorised use. Applications include testing of insulation systems and measurement of break down voltage of electrical plant and components.

- 0 - 100kV output voltage
- 1.2kVA to 20kVA output capability
- Key operated supply switch to prevent unauthorised operation
- Dual overload protection
- Variable electronic trip between 10-110% of rated output
- Voltage and current metering
- Zero-volt interlock
- Visual indication of test piece failure

## DC Cable Test Sets

We can offer from  $\pm 15kVdc$  to  $\pm 30kVdc$  units which all have automatic earthing for discharging capacitive loads. They are designed to perform tests on installed cables and jointing systems.

- Up to  $\pm 30kVdc$  output voltage
- 10mA output capability
- Both voltage and current metered on HV outputs
- Automatic earth system for dumping capacitive loads
- HV output plug & socket system
- Automatic mains voltage selection
- Key operated supply switch to prevent unauthorised operation
- Visual indication of test piece failure



# 200ADM-P Current Injection System



## Features

- 0-200A output current
- True RMS metering with 1 cycle capture
- Variable auxiliary AC voltage/current output with phase shift
- Auxiliary metering input V, f,  $\Phi$ , Z, P, S, PF, CT ratio, harmonics
- Variable auxiliary output 12-220VDC
- Multi-function auto-ranging timing system
- Current limit mode for fine control
- Data storage to USB memory key including waveform & harmonics
- USB keyboard/printer interface
- Automatic mains voltage selection

The 200ADM-P is a current injection system with a wide range of advanced features including phase shift, data storage and harmonic analysis.

The unit has a range of outputs allowing injection of currents between 1mA and 200A. Voltages up to 240V are available on the main outputs allowing high impedance current relays to be tested. True RMS metering with single cycle capture is provided. 4 current ranges allow the full scale of the meter and trip level to be set independently of the selected output. Industry standard safety connectors are used throughout for safe, reliable convenience.

The unit has a comprehensive timing system linked to the outputs allowing trip times, reset times and reclose times to be quickly measured to a high degree of accuracy. The timer includes a current operated mode and can accurately test instantaneous trips.

Two USB host sockets are provided to connect a memory key, keyboard or printer. Results of every test can be stored to the memory key in spreadsheet format for later analysis. The keyboard allows entry of a comment against each result. In addition a graphics file of the waveform may be stored to the memory key. Harmonic analysis results can also be recorded.

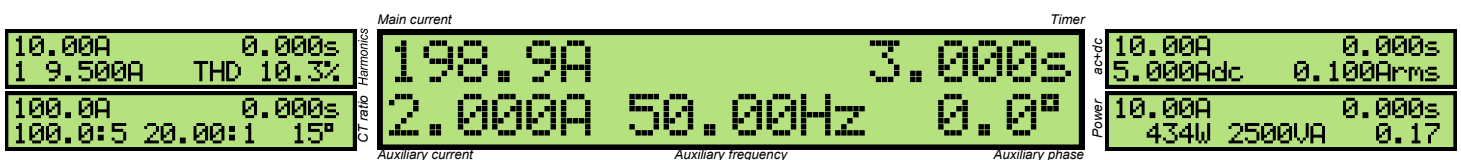

The 200ADM-P has a flexible auxiliary AC output that can be used at up to 260V for voltage relays or up to 10A for current relays. The phase and frequency of this output are fully adjustable. This combination of voltage and current allows testing of relays that require two voltages, one voltage and one current or two currents.

An auxiliary metering module is provided that meters AC and DC voltage, current and frequency from the auxiliary outputs or external signals. The module can also take measurements in conjunction with the main current output to meter phase angle, power, impedance, CT ratio and harmonics.

A variable stabilised DC supply with current limit is provided to power the relay under test.

## 200ADM-P Applications

IEEE no.	Type	IEEE no.	Type
21	Distance protection (phase at a time)	67	Directional overcurrent
24	Volts/Hz	67N	Directional ground fault
25	Check sync	78	Phase angle
27/59	Under/over voltage	79	Auto recloser
32/P/Q	Directional power	81	Under/over frequency
37	Under-current/power	85	Pilot wire relay
40	Field relay	86	Lockout relay
46N	Negative sequence overcurrent relay	87	Differential relay
50/76	Instantaneous overcurrent	91	Directional voltage relay
50	Ground fault relay	92	Power directional relay
50V	Voltage restrained overcurrent	94	Tripping relay
51	IDMT overcurrent relay		Voltage regulating relay
55	Power factor relay		Miniature circuit breakers
59G	Neutral voltage displacement		Thermal relays
			CT mag curves

## Auxiliary Metering

The auxiliary metering input on the 200ADM-P measures AC and DC voltage and current. The input is rated for 300V rms or 5/10A rms (10A for waveforms with a CF up to 1.5, 5A rms for a CF of 3).

The module can take measurements using the main output and auxiliary input together to measure phase angle, power, impedance and CT ratio (for both 1A and 5A CTs). It can also analyse the harmonic content of the main output and auxiliary input up to 31st harmonic and calculate the THD of the waveform. Measurements may be logged to the USB key.

- DC: Volts/Amps DC average & rms ripple
- AC: Volts/Amps AC rms, frequency & phase angle
- Power: S (VA), P (W) and power factor
- Impedance: Z, X & phase angle
- CT ratio: Ratio relative to 1A & 5A CT and phase angle
- Harmonic: Harmonics & THD on the main output & aux input

## Auxiliary AC Output

The auxiliary AC output supplies an extra isolated voltage or current to the relay under test. The output is a digitally generated pure sine wave, and three ranges are provided for maximum flexibility (two voltage ranges and one current range). The output is adjustable from zero and can be phase shifted through 360°. This output is also linked to the timer circuit.

### 1 Voltage—Over/Under Voltage Relays

Testing over and under voltage relays with the 200ADM-P is simple—even checking delay times. Connect the main output in series with the auxiliary output to generate voltage steps with timing.

### 1 Voltage—Frequency Relays

The auxiliary AC output can be either phase locked to the supply or switched to variable frequency mode. Operating points are easily determined and the response of the relay timed.

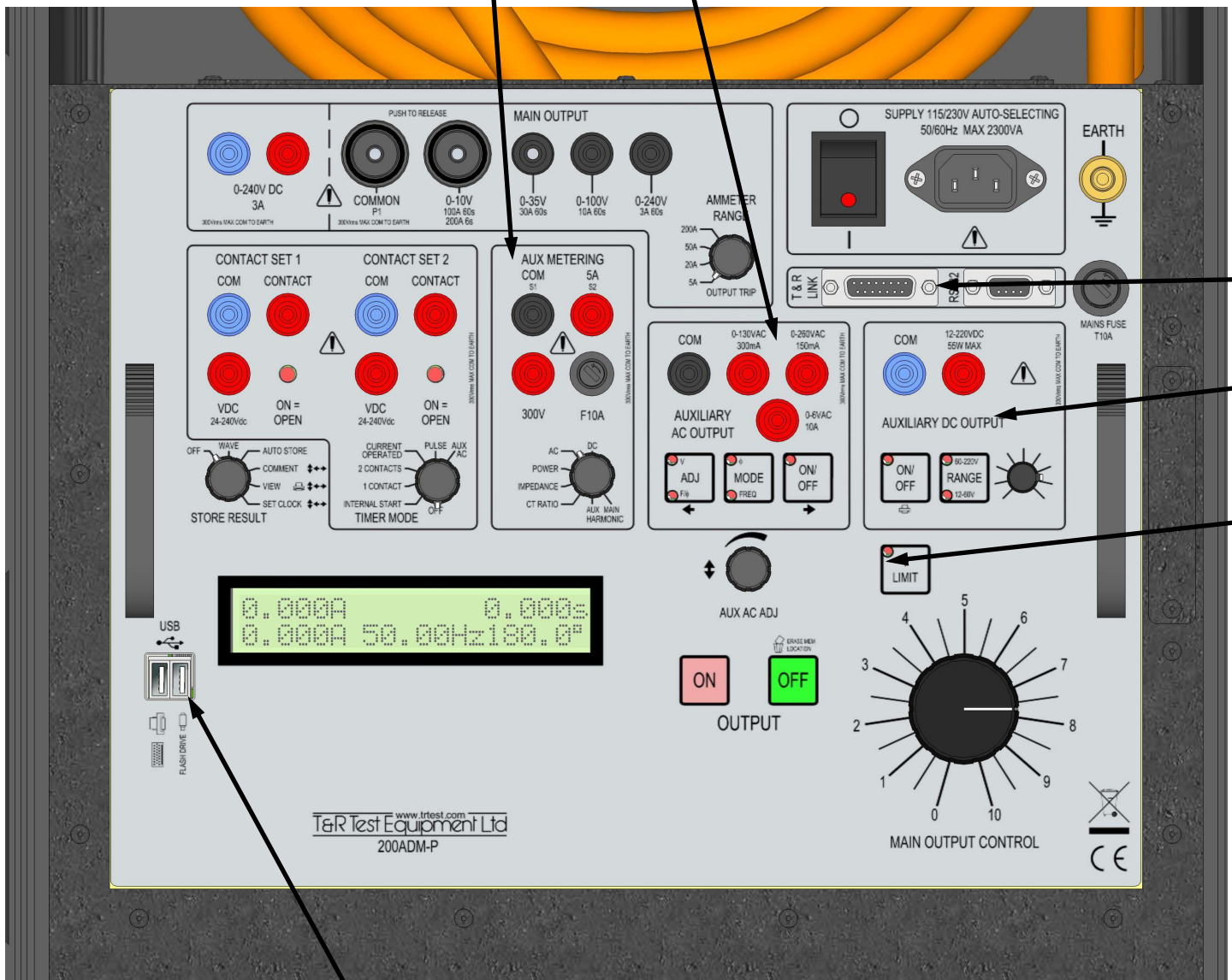

**USB ports** For connecting USB memory key, keyboard or printer.



## 1 Voltage + 1 Current—Various Relays

The phase shifting capability of the auxiliary output is ideal for testing directional overcurrent and earth fault relays. The main output is used to inject current and the auxiliary output supplies the voltage coil. The same configuration is used to test reverse power relays and phase at a time testing of distance protection. The test of these relays is eased further by the direct display of W, VA, phase angle and impedance. Testing an Automatic Voltage Regulating (AVR) relay with line drop compensation also requires a current and a voltage with phase-shift. The 200ADM-P is ideally suited to this test, and the two contact inputs can be used to show the state of the up/down contacts on the relay.

## 2 Currents—Bias Differential Relay

The 10A auxiliary AC output can be used to supply a second current to the relay under test as required by differential protection. This output is independent of the mains and can be used when a stabilised current is required.

## 2 Voltages—Check Sync Relay

The combination of the main output used as a voltage source and the auxiliary AC output meets the requirements of check-sync testing. With the auxiliary output set to variable frequency different frequencies may be applied to the two relay inputs for checking the frequency matching function of the relay. Switching to phase lock mode then allows the phase checking function of the relay to be tested.

**RS232** port for connection to a printer or PC.

**T&R Link** contact output and phase lock connection for DVS3.

## Auxiliary DC Output

The 200ADM-P has a stabilised, variable DC output for powering the relay under test with an output of 12-220V in two ranges. The output is current limited and can supply load requiring high inrush currents.

## I Limit

The 200ADM-P has a current limit function for the main output that gives very fine current control for currents up to 10A. Low impedance loads such as microprocessor relays present no problem to the 200ADM-P, currents can be accurately controlled down to a few mA.



## Timing

The timing system is linked to the main output and the auxiliary AC output. This allows timing of a wide range of devices.

Mode	Timer Start	Timer Stop
Internal start	Press 'ON'	Contact 1 or 2 change
1 contact	Contact 1 1st change	Contact 1 2nd change
2 contacts	Contact 1 change	Contact 2 change
Current operated	Current > 10% of metering range	Current < 10% of metering range
Pulse	Press 'ON'	200ms
Aux AC	Aux AC on/ switch freq to $\Phi$ / switch $\Phi$ to freq	Contact 1 or 2 change

For example, to time an IDMT current relay the relay contacts are connected to contact set 1 and "internal start" mode is selected. When the main output is switched on, current injection and the timer starts. When the relay trips the timer stops and the output is switched off. All contacts are sensitive to changes of state rather than setting for normally open or normally closed. At the end of a test when the timer stops the output is switched off to safeguard the relay under test. LEDs indicate the contact state.

Setting the timer to AUX AC starts the timer when the auxiliary AC output is switched on or the output is switched from variable frequency to phase control or vice versa. This is ideal for testing trip times on under or over voltage protection and testing Check Sync Relays.

In addition the unit will time between changes on one set of contacts or two sets of contacts. Current operated mode starts and stops the timer on the rise and fall of current on the main output. This mode will test devices where the breaking contacts are in series with the sense circuit, as in thermal or thermal-magnetic circuit breakers.

Pulse mode is used for setting the current level in devices sensitive to heating. Current is injected for 200ms and the current recorded.

## Storage of Results

All test results from the 200ADM-P can be stored in a USB memory key. The unit has a real-time clock to time and date-stamp all results. To log the results, first enter a comment for your results using the digital pot and arrow keys or optional keyboard, and then select AUTO STORE. Whenever the timer stops, the time, current and all other parameters are added to a spreadsheet file on the USB key. You can then view the current set of results on the display or take the USB key out and open the file on your PC. All results are

stored in a folder on the USB key named with the test date in a file named with the time.

In addition, the 200ADM-P can store a .BMP file of the waveform to the USB key.

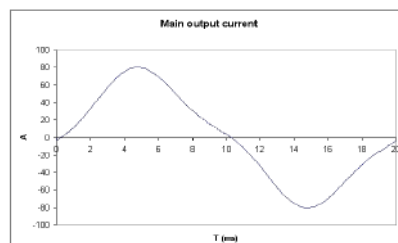

## Sample data stored on USB key

```
Time, Date, Main A, Timer, Aux A, Aux V, Phase, Freq Hz, Comment
10:53:12,12/12/09, 2.000, 10.000, 0.000, 10.0, 10.3, 50.00, Overcurrent subl relay 12
10:53:30,12/12/09, 5.000, 3.000, 0.000, 10.0, 10.3, 50.00, Overcurrent subl relay 12
10:54:10,12/12/09, 10.00, 1.000, 0.000, 10.0, 10.3, 50.00, Overcurrent subl relay 12
```

## 200ADM-P Specification

### Main Output

The main output on the unit has four taps, allowing the selection of output voltages up to 240V and output currents up to 200A.

Range	Current				Output @230V	
	Cont	5 min*	1 min*	6 sec**	O/C	Load V
10V	33A	67A	100A	200A	10.5V	8.7V@100A
35V	10A	20A	30A	-	36V	32V@30A
100V	3A	6A	10A	-	108V	99V@10A
240V	1A	2A	3A	-	276V	259V@3A
240Vdc	1A	2A	3A	-		

\*Off time of 15 minutes. On times based on an ambient temperature of 25°C.  
\*\*6 second intermittent ratings available with 230V supply.

Protection: over current trip, duty cycle trip, thermal monitoring.

### I Limit Mode

The main output has a current limit mode that gives very fine control of output currents up to 10A. It also allows fine current control into very low impedance loads such as digital relays.

Range	Current (A)				Output V @230V	
	Short circuit	Cont.	5 min	2 min	O/C	Load V
10V	10A	3A	6A	10A	8.6V	5V@5A
35V	3A	1A	2A	3A	29V	13V@2A
100V	1A	0.3A	0.6A	1A	88V	40V@0.6A
240V	0.3A	0.1A	0.2A	0.3A	224V	130V@0.2A

### Auxiliary DC Output

Range	Maximum A	Continuous rating
12-60V	1A	25W
60-220V	0.23A	25W

Protection: current limit.

### Phase-shifting AC Output

Range	Maximum Output Voltage		Current	Current
	No load	Full load		
Range			Continuous	5 min on/ 15 min off
0-130V	144V	125V	0.23A	0.46A
0-260V	288V	250V	0.11A	0.23A
0-6V	6.6V	5V	5A	10A

Frequency range: 45–100Hz

Phase angle: 0–±180°

Protection: current limit & electronic trip.

### Metering

The output is metered by a digital true RMS system with a single cycle capture memory ammeter—whenever the timer stops and the output is switched off, the current reading is held on the display. A current trip is set to 110% of full scale of the selected metering range.

Range	Resolution	Trip current	Accuracy	Acquisition time
5.000A	0.001A	5.5A	±0.5%rdg±5d	20ms
20.00A	0.01A	22A	±0.5%rdg±5d	20ms
50.00A	0.01A	55A	±0.5%rdg±5d	20ms
200.0A	0.1A	220A	±0.5%rdg±5d	20ms

### Auxiliary Metering Inputs

Setting	Range	Resolution	Accuracy
Vdc/AC rms	300.0V	0.1V	±0.7%rdg±5d
I <sub>dc</sub> /AC rms	5.000A CF<3 9.999A CF<1.5	0.001A	±0.7%rdg±5d
Phase	-179.9°— +180.0°	0.1°	±3°
Frequency	40—100Hz	0.01Hz	±0.02%rdg±1d

Protection: fuse on current input.

### Timing System

Range 0-999.999s/9999.99s/99999.9s autoranging  
Resolution 1/10/100ms  
Accuracy 0.01%rdg+2d (+4d current operated mode)  
Contact o/c 24V  
Contact s/c 20mA  
Vdc 24–240V

Each contact circuit will auto-select for normally open or normally closed contacts. A DC voltage of 24–240Vdc may also be used to trigger either timer channel. Contact state is shown by an LED.

### Supply Requirements

115V/230V ±10% auto-selecting 50/60Hz 1ph 2300VA max.

### Accessories

The 200ADM-P is supplied with operating manual, output lead set, mains lead, spare fuses, USB keyboard, USB memory key.

### Lead Set specifications

The 200ADM-P is supplied with a high quality lead set including:  
2 x 5m 25mm<sup>2</sup> 200A leads terminated in M10 fork crimps  
2 x 5m, 2 x 0.5m 2.5mm<sup>2</sup> 25A leads terminated in 4mm plugs  
1 x 5m 2 core auxiliary leads terminated in 4mm plugs.

### Optional accessories

Filter unit, RB10 resistor box, printer, pushbutton lead for runback timing on disc induction relays.

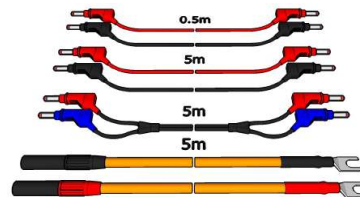

### Safety

An earth terminal is provided for connection to a local earth. The unit is designed to comply with BSEN61010 and is CE marked.

### Temperature Range

Storage -20°C to 60°C      Operating 0°C to 45°C

### Dimensions

560 x 456 x 265mm

### Weight

22.6kg

# 100ADM Current Injection System mk4

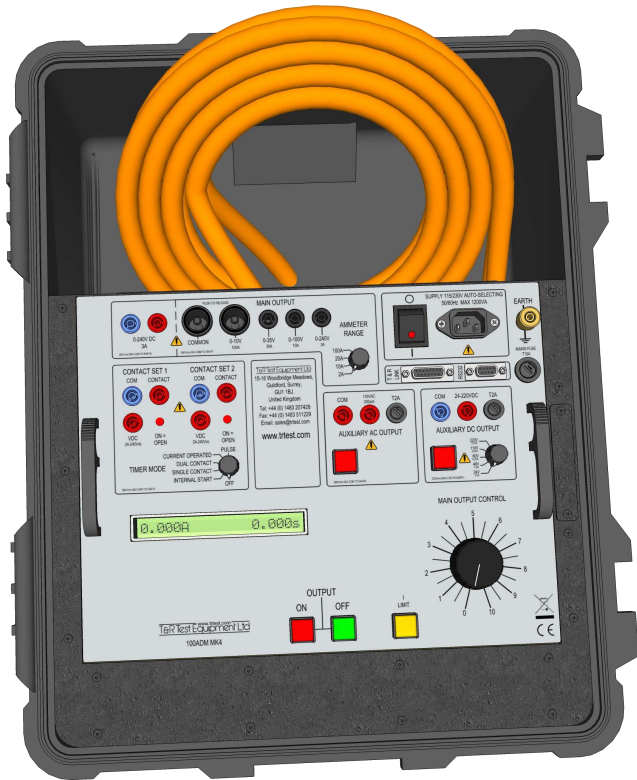

## Features

- Clear and simple user interface
- 0-100A output current
- Current limit mode for fine current control
- True RMS metering with single cycle capture memory ammeter
- Multi-function auto-ranging timing system
- Auxiliary DC and AC output
- Large back-lit liquid crystal display
- Thermal and over-current protection
- Compact and portable
- Automatic mains voltage selection

The 100ADM mk4 provides commissioning and maintenance engineers with a flexible system for testing protective systems. It has an easy to understand panel layout and a simple user interface. The status of every function can be seen at a glance, and there are no complex menus to navigate.

The 100ADM mk4 keeps the familiar user interface of previous models but adds a new metering system that accurately measures the RMS of a single cycle. It also features a new current limit mode to provide very fine control of low currents, even into low impedance loads. Current limit mode also assists in testing self-powered overcurrent protection as fitted to many 11kV ring main units.

*The back-lit display on the 100ADM mk4 is bright and clear with a wide viewing angle. The results of a test can be seen here as they appear on the display.*

A 24-220VDC switch-mode stabilised DC supply with current limiting is provided to power the relay under test. An isolated, separately switched 110VAC auxiliary supply is also provided.

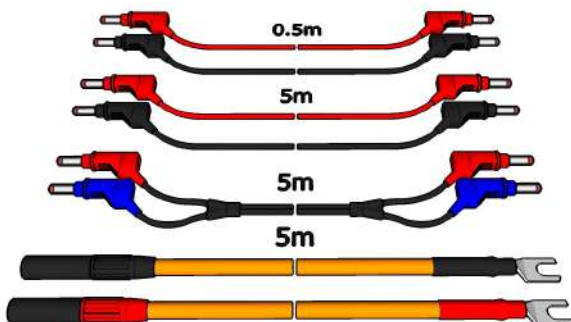

The unit has a range of outputs allowing injection of currents as low as a few mA and as high as 100A. Voltages up to 240V are available allowing high impedance current relays and voltage relays to be tested. Four true RMS metering ranges are provided, and the full scale of the meter (and trip level) can be set independently of output tap. Industry standard safety connectors are used on all inputs and outputs for convenience, reliability and safety.

A very flexible two channel timing system is provided, allowing trip times, reset times and reclose times to be quickly measured to a high degree of accuracy. The timer auto-ranges to measure from 1ms to 99999.9s.



The outputs of the 100ADM mk4 are well protected. The main output is protected by overcurrent, duty cycle and thermal trips. The auxiliary DC supply is protected by a current limit, and the auxiliary AC supply is fuse protected.

## 100ADM mk4 Applications

IEEE no.	Type	IEEE no.	Type
27/59	Under/over voltage	79	Auto recloser
37	Undercurrent	86	Lockout relay
50/76	Instantaneous overcurrent	94	Tripping relay
	Ground fault relay	90V	Voltage regulating relay
51	IDMT overcurrent relay		Miniature circuit breakers
59G	Neutral voltage displacement		Circuit breakers for equipment
67	Directional overcurrent (basic tests)		Thermal relays

# 100ADM mk4 Specification

## Main Output

The main output on the unit has four taps, allowing the selection of output voltages up to 240V and output currents up to 100A.

Range	Current			Output @230V	
	Cont	5 min*	1 min*	O/C	Load V
10V	33A	67A	100A	10.5V	8.7V@100A
35V	10A	20A	30A	36V	32V@30A
100V	3A	6A	10A	108V	99V@10A
240V	1A	2A	3A	276V	259V@3A
240Vdc	1A	2A	3A		

\*Off time of 15 minutes. On times based on an ambient temperature of 25°C.

## I Limit Mode

The main output has a current limit mode that gives very fine control of output currents up to 10A. It also allows fine current control into very low impedance loads such as digital relays.

Range	Current (A)				Output V @230V	
	Short circuit	Cont.	5 min	2 min	O/C	Load V
10V	10A	3A	6A	10A	8.6V	5V@5A
35V	3A	1A	2A	3A	29V	13V@2A
100V	1A	0.3A	0.6A	1A	88V	40V@0.6A
240V	0.3A	0.1A	0.2A	0.3A	224V	130V@0.2A

## Auxiliary AC and DC Outputs

A switched, isolated auxiliary DC supply with current limit protection is available to power the relay under test, and a 110VAC auxiliary output is available for tests.

DC stabilised output	24V, 48V, 60V	1.0A
	110V, 220V	0.23A
Fixed AC output	110VAC	300mA

## Metering

The output is metered by a digital true RMS system with a single cycle capture memory ammeter—whenever the timer stops and the output is switched off, the reading is held on the display. A current trip is set to 110% of full scale of the selected metering range.

Range	Resolution	Trip current	Accuracy	Acquisition time
2.000A	0.001A	2.2A	±0.5%rdg±5d	20ms
10.00A	0.01A	11A	±0.5%rdg±5d	20ms
20.00A	0.01A	22A	±0.5%rdg±5d	20ms
100.0A	0.1A	110A	±0.5%rdg±5d	20ms

## Supply Requirements

115/230V±10% auto-selecting 50/60Hz 1ph 1200VA max

## Timing System

Range	0-999.999s/9999.99s/99999.9s autoranging
Resolution	1/10/100ms
Accuracy	0.01%rdg+2d (+4d current operated mode)
Contact o/c	24V
Contact s/c	20mA
Vdc	24–240V

Each contact circuit will auto-select for normally open or normally closed contacts. A DC voltage of 24–240VDC may also be used to trigger either timer channel. Contact state is shown by an LED. The output automatically switches off at the end of the test to safeguard the relay under test.

Mode	Timer Start	Timer Stop
Internal start	Press 'ON'	C1 or C2 change
1 contact	C1 1st change	C1 2nd change
2 contacts	C1 change	C2 change
Current operated	Current > 10% of metering range	Current < 10% of metering range
Pulse	Press 'ON'	200ms

Pulse mode is used for setting the current level in devices sensitive to heating. Current is injected for 200ms.

## RS232 and T&R Link

An RS232 port is provided to allow connection to a PC or a printer. The T&R Link output allows a T&R DVS3 mk2 voltage source to phase lock to the 100ADM mk4 current.

## Protection and Safety

The unit is designed to comply with BSEN61010 and is CE marked. An earth terminal is provided for connection to a local earth for testing in sub-station environments.

<b>Dimensions</b>	<b>Weight</b>
560 x 456 x 265mm	23.9kg

## Temperature Range

Storage	-20°C to 60°C	Operating	0°C to 45°C
---------	---------------	-----------	-------------

## Lead Set specifications

The 100ADM mk4 is supplied with a lead set consisting of:  
 2 x 5m 25mm<sup>2</sup> 100A leads terminated in M10 ring crimps  
 2 x 5m, 2 x 0.5m 2.5mm<sup>2</sup> 25A leads terminated in 4mm plugs  
 1 x 5m 2 core 0.75mm<sup>2</sup> lead terminated in 4mm plugs

## Accessories

Operating manual, output lead set, mains lead and spare fuses.

## Optional Accessories

100ADM-F Filter unit, RB10 resistor box, Printer, pushbutton lead for runback timing on disc induction relays.



# 100A/E Current Injection System



## Features

- Wide range of output currents
- AC and DC voltage outputs
- All outputs continuously variable
- Output current metering from 40mA-200A
- Automatic switch-off in all modes of operation
- Multi-function timing system
- Suitable for testing thermal devices
- Compact and highly portable
- Voltage and current outputs available simultaneously

T&R Test Equipment is a market leader in the field of current injection equipment. The range includes secondary injection units with 100A output capability up to 6000A primary injection systems. All have true RMS metering, a flexible timing system, and an easy to understand user interface.

The 100A/E Mk3 secondary current injection test set has been designed to give the maintenance and commissioning engineer a large number of facilities in one self-contained instrument.

The unit is portable, compact and simple to use. The mains supply for the unit is either 240V±10% or 115V +10% -6% at either 50 or 60Hz. Full load can be obtained at the supply voltage extremes.

The current and voltage outputs are independently controlled and metered. The output current and voltage are displayed on large, clear panel instruments. An additional four range CT is provided, extending the ammeter range down to 0-100mA.

All of the outputs are fully isolated by means of double wound transformers.

The timing system on the 100A/E is very flexible, without compromising ease of use. Four modes of operation and two contact inputs are provided allowing for a wide range of events to be timed. Both contact inputs automatically select for normally open or normally closed contacts. Operation of the different timing modes is described on page 10.

Internal start mode starts the timer when the 'ON' pushbutton is pressed, and stops the timer when the first contact set changes state. This mode is ideally suited to timing over-current relays.

Single contact mode starts and stops the timer on the first and second changes of state of the first contact set, and dual contact mode starts the timer from the first set of contacts and stops it from the second set. These modes allow reset and re-close times of protective devices to be easily measured.

The final mode of operation of the timer starts the timer when the current exceeds 20% of the selected metering range, and stops it when the current falls below 20%. This allows the timing of trips with no auxiliary contacts such as miniature circuit breakers.

Automatic control has been provided such that all outputs can be switched "off once the device under test has operated. The automatic control can be switched in or out of circuit for all outputs, enabling setting up procedures to be carried out.

The instrument is housed in a robust case complete with a protective cover and fold away carrying handles.

## 100A/E Mk3 Specification

### Current Output

The current output on the unit has eight ranges, allowing the selection of output voltages up to 150V and output currents up to 200A. The current outputs may also be used as voltage outputs.

Range	Continuous	5 minutes	1 minute	VAC
200A	50A	100A	200A	0-5V
50A	25A	50A	-	0-10V
25A	12.5A	25A	-	0-20V
10A	5.0A	10A	-	0-50V
5.0A	2.5A	5.0A	-	0-50V
2.5A	1.25A	2.5A	-	0-50V
1.0A	0.5A	1.0A	-	0-150V

The above intermittent ON times must be followed by an OFF time of 15 minutes, and are based on an ambient temperature of 25°C.

### Voltage Output

The voltage output on the unit has three ranges, allowing the selection of output voltages up to 500VAC and 250VDC.

Range	Continuous	5 minutes
0-250VAC	0.5A	1.0A
0-500VAC	0.25A	0.5A
0-250Vdc	0.5A	1.0A

The above intermittent ON times must be followed by an OFF time of 15 minutes, and are based on an ambient temperature of 25°C.

### Metering

The output is metered by an analogue true RMS system with separate instruments for current and voltage.

AC current is metered by a dual scaled ammeter reading 0-1A and 0-5A. The following scaling factors are used:

Range	1A Scale	5A Scale	Accuracy
0.1A	x0.1	x0.02	Class 1.5
0.25A	x0.25	x0.05	Class 1.5
0.5A	x0.5	x0.1	Class 1.5
1.0A	x1	x0.2	Class 1.5
2.5A	x2.5	x0.5	Class 1.5
5.0A	x5	x1	Class 1.5
10A	x10	x2	Class 1.5
25A	x25	x5	Class 1.5
50A	x50	x10	Class 1.5
100A	x100	x20	Class 1.5
200A	x200	x40	Class 1.5

AC voltage is metered by a dual scaled ammeter reading 0-300V and 0-600V. The following scaling factors are used:

Range	300V Scale	600V Scale	Accuracy
300V	x1	x0.5	Class 1.5
600V	x2	x1	Class 1.5

### Timing System

<b>Range</b>	0-999.999s
<b>Resolution</b>	1ms
<b>Accuracy</b>	±0.1% rdg ±2d (all modes except current op.)
<b>Accuracy</b>	±0.1% rdg ±3d (current operated mode)

The contact circuit has an open circuit voltage of 24VDC and a short circuit current of 100mA. Each contact circuit will auto-select for normally open or normally closed contacts. A DC voltage of 24-240VDC may also be used to trigger either timer channel.

The following functions are provided:

Mode	Timer Start	Timer Stop
Internal start	Press 'ON'	Contact 1
Single contact	Contact 1	Contact 1
Dual contact	Contact 1	Contact 2
Current operated	Current > 20% of range	Current < 20% of range

The output may be automatically switched off at the end of the test to safeguard the relay under test. This is selectable for both the voltage and current output.

### Protection and Safety

The unit is protected by the following fuses:

Input supply	T5A 240V supply T10A 115V supply
Output supplies	T3.15A
Contacts	F0.25A
Aux CT circuit	T315mA and T1.25A

An earth terminal is provided for connection to a local earth.

### Supply Requirements

115V+10%-6% 50/60Hz 1ph 1450VA max  
240V±10% 50/60Hz 1ph 1450VA max

### Temperature Range

Storage -20°C to 60°C  
Operating 0°C to 45°C

### Dimensions

490 x 300 x 300mm

### Weight

33kg

### Accessories

Operating manual  
2m mains lead  
Non-latching contact lead  
100AL lead set  
Spare fuse set

### Optional Accessories

100ADM-F 100A Waveform Filter unit

# 100ADM-F

## Current Filter Unit



Current waveforms

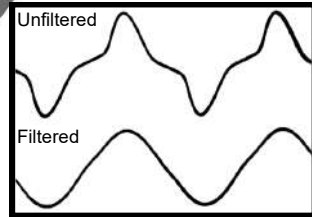

### Features

- Forces test current to a sinusoid
- Improves timing accuracy when testing electromechanical relays
- 0.25A-100A ranges
- High overload capability
- 50/60Hz operating frequency
- High efficiency

The 100ADM-F filter unit reduces the level of current harmonics when testing electro-mechanical protection relays. It is designed for use with our range of secondary injection test sets.

All electromechanical protection relays have iron cores that saturate and distort the test current under high overload test conditions. This distortion causes significant errors in the measured trip time of these relays during testing. Distortion of the waveform can be a particular problem with disc induction type over-current and sensitive earth fault relays.

For example, testing a CDG11 disc induction over-current relay without a filter causes significant timing errors. The results below show the errors for a 1.3s 1A CDG11 over-current relay on its 0.5A plug setting, tested at 5A.

	Current	THD	Trip time	Error
No Filter	5A	34.5%	1.54s	18.5%
With Filter	5A	6.12%	1.30s	0%

The 100ADM-F has nine current ranges covering 0.25A to 100A and is supplied in an insulated case complete with protective cover and carrying strap.

# RB10

## Resistor Box

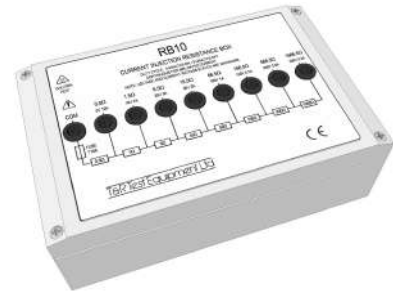

### Features

- Improves current control into low impedance loads
- Particularly suitable for solid state relays
- 0.5Ω—1666.5Ω in 8 steps
- Maximum current 0.2—10A
- Thermal cutout
- Compact & lightweight

The RB10 resistor box is used in conjunction with a current injection unit when testing low impedance relays and trips, allowing finer control of the current. The unit is designed for use with the 100ADM and 200ADM, but may be used with any suitable current source.

The unit has eight resistance ranges with a maximum power dissipation of 50W for any one resistor.

Range	Continuous current	Intermittent current*	Maximum voltage
0.5Ω	5A	10A	5V
1.5Ω	3.5A	7A	10V
6.5Ω	1.5A	3A	25V
16.5Ω	1A	2A	50V
66.5Ω	0.5A	1A	100V
166.5Ω	0.35A	0.7A	150V
666.5Ω	0.15A	0.3A	250V
1666.5Ω	0.1A	0.2A	250V

\*3 minutes on/8 minutes off

The RB10 is supplied in a robust aluminium case, and all connections are made by industry standard 4mm safety sockets.

The RB10 has fuse and over-temperature protection.

## 100ADM-F Specification

### Current Waveforms

The waveforms below show the current and voltage for a disc induction type relay supplied from a 100ADM.

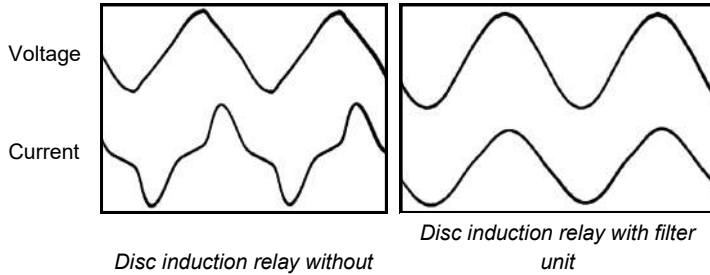

### Current Ranges and Ratings

Range	Continuous rating	5 min on/ 15 min off
0.25A	0.125A	0.25A
0.5A	0.25A	0.5A
1A	0.5A	1A
2.5A	1.25A	2.5A
5A	2.5A	5A
10A	5A	10A
25A	12.5A	25A
50A	25A	50A
100A	50A	100A

### Frequency

The unit may be used at either 50Hz or 60Hz, selectable by a switch on the front panel.

### Range Selection

The lower ranges (0.25A-50A) are selected by a switch, and the highest current range (100A) is selected by a terminal.

### Current Monitor

A current monitoring output is provided that gives an output of 0-100mA corresponding to the rated current for the range.

### Filter Unit Impedance

Range	Impedance ( $\Omega$ )			
	50Hz	150Hz	250Hz	350Hz
0.25A	880 $\Omega$	17.5k $\Omega$	30.4k $\Omega$	41.5k $\Omega$
0.5A	220 $\Omega$	4.38k $\Omega$	7.65k $\Omega$	10.3k $\Omega$
1A	47.7 $\Omega$	950 $\Omega$	1.65k $\Omega$	2.25k $\Omega$
2.5A	7.8 $\Omega$	150 $\Omega$	250 $\Omega$	360 $\Omega$
5A	1.94 $\Omega$	38 $\Omega$	65 $\Omega$	90 $\Omega$
10A	510m $\Omega$	9.5 $\Omega$	16.5 $\Omega$	22.5 $\Omega$
25A	85m $\Omega$	1.5 $\Omega$	2.5 $\Omega$	3.6 $\Omega$
50A	22m $\Omega$	380m $\Omega$	650m $\Omega$	900m $\Omega$
100A	5.5m $\Omega$	95m $\Omega$	165m $\Omega$	225m $\Omega$

### Temperature Range

Storage	-20 °C to 60 °C
Operating	0 °C to 45 °C

### Dimensions

340 x 230 x 330mm

### Weight

15.6kg

### Accessories

Current monitor plug and lead

### Optional Accessories

100AL lead set

## RB10 Specification

### Resistance Ranges and Ratings

The RB10 has eight resistance ranges.

Range	Continuous current	Intermittent current*	Maximum voltage
0.5 $\Omega$	5A	10A	5V
1.5 $\Omega$	3.5A	7A	10V
6.5 $\Omega$	1.5A	3A	25V
16.5 $\Omega$	1A	2A	50V
66.5 $\Omega$	0.5A	1A	100V
166.5 $\Omega$	0.35A	0.7A	150V
666.5 $\Omega$	0.15A	0.3A	250V
1666.5 $\Omega$	0.1A	0.2A	250V

\*3 minutes on/8 minutes off

### Range Selection

The appropriate range is selected by 4mm safety sockets on the front panel of the unit.

### Temperature Range

Storage	-20 °C to 60 °C
Operating	0 °C to 45 °C

### Protection

The unit has over-temperature protection and the common terminal is fused with a T10A fuse.

### Dimensions

220 x 163 x 72mm  
including earth terminal

### Weight

2Kg

### Optional Accessories

S000-0534 5m low current lead set



# 50A-3PH 3 Phase Current Injection System mk2



## Features

- Clear and simple user interface
- 3 phase current output
- 0-50A per phase output current
- True RMS digital metering
- Memory ammeter
- Multi-function timing system
- Auxiliary metering input
- Large back-lit liquid crystal display
- Thermal and over-current protection
- Compact and portable
- 220V 3 $\phi$  or 400V 3 $\phi$  supply options\*
- 115V-440V 3 wire supply with optional supply transformer

\*See supply requirements overleaf

T&R Test Equipment is a market leader in the field of current injection equipment. The range includes secondary injection units with 50A output capability up to 6000A primary injection systems. All have true RMS metering, a flexible timing system, and an easy to understand user interface.

The 50A-3PH mk2 is a three phase injection system providing commissioning and maintenance engineers with a flexible system for testing protective systems. It has an easy to understand panel layout and a simple user interface. The status of every function can be seen at a glance, and there are no complex menus to navigate.

*The back-lit display on the 50A-3PH mk2 is bright and clear with a wide viewing angle. The results of a test can be seen here as they appear on the display*

The unit is designed to comply with BSEN61010, and is CE marked.

An auxiliary metering input is provided and can measure voltage, current, frequency, and the phase between any of the current outputs and an external voltage or current.

The timing system is very flexible without compromising ease of use, allowing trip times, reset times and reclose times to be quickly measured to a high degree of accuracy. Two independently isolated contact inputs are provided, and the timing system may also be used as a stand-alone timer.

The unit has a range of outputs allowing injection of currents as low as a few mA and as high as 50A. Voltages up to 18V are available on the main outputs. Three true RMS metering ranges are provided, allowing the full scale of the meter and trip level to be set independently of the selected output. Industry standard safety connectors are used on all inputs and outputs for convenience, reliability and safety.

The 50A-3PH mk2 is protected by electronic over current and duty cycle trips on the outputs, thermal monitoring on the power components, and fuses on the input and regulator. An earth terminal is provided for connection to a local earth.



The 50A-3ph mk2 can be used to test many types of single and three phase secondary protection including:

- Over and under current relays
- Earth fault relays
- IDMT relays
- Miniature circuit breakers
- Auto-reclosers
- Power relays
- Time delay relays
- Tripping relays
- Thermal relays

## 50A-3PH mk2 Specification

### Main Output

The main output on the unit has two taps, allowing the selection of output voltages up to 18V and output currents up to 50A.

Range	Continuous	5 minutes	1 minute
3.5V	16A	32A	50A
18V	4A	8A	12A

The above intermittent on times must be followed by an off time of 15 minutes, and are based on an ambient temperature of 25°C.

### Metering

The output is metered by a digital true RMS system with a memory ammeter - whenever the timer stops and the output is switched off, the current reading is held on the display. The currents for each phase are displayed simultaneously.

Range	Resolution	Trip current	Accuracy
5.000A	0.001A	5.25A	±0.6%rdg+5d
20.00A	0.01A	21A	±0.6%rdg+5d
50.00A	0.01A	52.5A	±0.6%rdg+5d

A current trip is automatically set to 105% of full scale of the current metering range to protect the device under test.

### Auxiliary Metering Inputs

An auxiliary metering input is provided which is able to measure RMS voltage or current. In addition the frequency of the external input may be measured, and the phase measured between any of the phase outputs and the auxiliary metering input.

Setting	Range	Resolution	Accuracy
Volts AC	270.0V0.1V		±0.7%rdg+5d
Amps AC	5.000A1mA		±0.7%rdg+5d
Phase	±180°	0.1°	±3°
Frequency	20-1000Hz	0.1Hz	±0.2%rdg+1d

The current input is protected by a F6.3A fuse.

### Auxiliary Output

A single phase isolated 110VAC 300mA/220VAC 150mA auxiliary output is provided on the 50A-3PH mk2.

### Lead Set Specifications

The 50A-3PH is supplied with a lead set including:

6 x 3m 4mm<sup>2</sup> output leads terminated in 4mm plugs.

2x3m, 2x0.5m, 2.5mm<sup>2</sup> auxiliary leads terminated in 4mm plugs

### Supply Requirements

The supply voltage requirements for the unit must be specified at the time of ordering. The unit is available for operation from either a 400V 4 wire 3 $\phi$  supply or 220V 3 wire 3 $\phi$  supply. The optional delta-star supply transformer allows the 400V unit to operate from other supply voltages.

**Supply option 1:** 400V-10%+14% 50/60Hz 3ph 1000VA

**Supply option 2:** 220V-6%+14% 50/60Hz 3ph 1000VA

### RS232 and T&R Link

An RS232 port is provided to allow connection of a printer or PC and the T&R link output provides a phase lock reference for a DVS3 phase-shifting voltage source.

### Timing System

<b>Range</b>	0-999.999s	Resolution	1ms
<b>Accuracy</b>	0.01%rdg+2d (+4d current operated mode)		

The contact circuit has an open circuit voltage of 24Vdc and a short circuit current of 20mA. Each contact circuit will auto-select for normally open or normally closed contacts. A DC voltage of 24-240Vdc may also be used to trigger either timer channel. The output is automatically switched off at the end of the test to safeguard the relay under test.

The following functions are provided:

Mode	Timer Start	Timer Stop
Internal start	Press 'ON'	Contact 1
Single contact	Contact 1	Contact 1
Dual contact	Contact 1	Contact 2
Current operated	Current > 10% of range	Current < 10% of range

Pulse mode is used for setting the current level in devices sensitive to heating, and allows current to be injected for 500ms and the current recorded.

Current operated mode operates on one output phase (selectable).

### Temperature Range

Storage	-20°C to 60°C	Operating	0°C to 45°C
---------	---------------	-----------	-------------

### Accessories

Operating manual, output lead set, mains lead, spare fuse set

### Optional Accessories

Delta-Star supply transformer, filter unit, printer, leadset carry case.



### Dimensions

560 x 456 x 265mm

### Weight

24.9kg

### Optional Delta-Star Supply Transformer

The optional delta-star supply transformer allows operation from 115V, 230V, 400V, and 440V 3 wire supplies, selected by a switch on the unit. An auxiliary single phase output is also provided to supply power to a DVS3 voltage source.

Input: 115V, 230V, 400V, 440V ±10% 3 wire  
3 phase 1500VA max

3 $\phi$  output: 400V 4 wire 600VA  
1 min on/15 min off

1 $\phi$  output: 230V 300VA  
5 min on/15 min off



# 200A-3PH 3 Phase Current Injection System mk2



## Features

- Clear and simple user interface
- 3 phase current output
- 0-200A per phase output current
- True RMS digital metering
- Memory ammeter
- Multi-function timing system
- Auxiliary metering input
- Large back-lit liquid crystal display
- Thermal and over-current protection
- Compact and portable
- 400V 3 $\phi$  supply.
- 115V-440V 3 wire supply with optional supply transformer

See supply requirements overleaf

T&R Test Equipment is a market leader in the field of current injection equipment. The range includes secondary injection units with 50A output capability up to 6000A primary injection systems. All have true RMS metering, a flexible timing system, and an easy to understand user interface.

The 200A-3PH mk2 is a three phase injection system providing commissioning and maintenance engineers with a flexible test set for testing protective systems. It has an easy to understand panel layout and a simple user interface. The status of every function can be seen at a glance, and there are no complex menus to navigate.

*The back-lit display on the 200A-3PH mk2 is bright and clear with a wide viewing angle. The results of a test can be seen here as they appear on the display.*

An auxiliary metering input is provided and can measure voltage, current, frequency, and the phase between any of the current outputs and an external voltage or current.

The timing system is very flexible without compromising ease of use, allowing trip times, reset times and reclose times to be quickly measured to a high degree of accuracy. Two independently isolated contact inputs are provided, and the timing system may also be used as a stand-alone timer.

The outputs are isolated and independently variable, allowing injection of currents up to 200A. Voltages up to 5V are also available on the main outputs. Four true RMS metering ranges are provided, allowing the full scale of the meter and trip level to be set independently of the selected output. Industry standard safety connectors are used on all inputs and outputs for convenience, reliability and safety.

The 200A-3PH mk2 is protected by electronic over current and duty cycle trips on the outputs, thermal monitoring on the power components, and fuses on the input and regulator. An earth terminal is provided for connection to a local earth. The unit is designed to comply with BSEN61010, and is CE marked.



The 200A-3ph mk2 can be used to test many types of single and three phase secondary protection including:

- Over and under current relays
- IDMT relays
- Auto-reclosers
- Time delay relays
- Earth fault relays
- Miniature circuit breakers
- Power relays
- Tripping relays
- Thermal relays

## 200A-3PH mk2 Specification

### Main Output

The test set has three independently controlled outputs, one for each phase, allowing the selection of output voltages up to 5V and output currents up to 200A.

Range	Continuous	5 minutes	1 minute
0-5V	50A	100A	200A

The above intermittent on times must be followed by an off time of 15 minutes, and are based on an ambient temperature of 25°C.

### Metering

The output is metered by a digital true RMS system with a memory ammeter - whenever the timer stops and the output is switched off, the current reading is held on the display. The currents for each phase are displayed simultaneously.

Range	Resolution	Trip current	Accuracy
20.00A	0.01A	21.0A	$\pm 0.6\%rdg+5d$
50.00A	0.01A	52.5A	$\pm 0.6\%rdg+5d$
100.00A	0.1A	105.0A	$\pm 0.6\%rdg+5d$
200.00A	0.1A	210.0A	$\pm 0.6\%rdg+5d$

A current trip is automatically set to 105% of full scale of the current metering range to protect the device under test.

### Auxiliary Metering Inputs

An auxiliary metering input is provided which is able to measure RMS voltage or current. In addition the frequency of the external input may be measured, and the phase measured between any of the phase outputs and the auxiliary metering input.

Setting	Range	Resolution	Accuracy
Volts AC	300.0V	0.1V	$\pm 0.7\%rdg+5d$
Amps AC	10.000A	1mA	$\pm 0.7\%rdg+5d$
Phase	$\pm 180^\circ$	$0.1^\circ$	$\pm 3^\circ$
Frequency	40-100Hz	0.01Hz	$\pm 0.2\%rdg+1d$

The current input is protected by an F10A fuse.

### Auxiliary Output

A single phase isolated 110VAC 300mA auxiliary output is provided on the 200A-3PH mk2.

### Lead Set Specifications

The 200A-3PH mk2 is supplied with a lead set in a plastic case including:

- 6 x 5m 25mm<sup>2</sup> output leads terminated in M10 fork crimps.
- 1 x 5m 2 core auxiliary timer lead terminated in 4mm plugs.

### Supply Requirements

The unit must be supplied by a 400V $\pm 10\%$  50/60Hz 3 phase 3300VA Max. The optional delta-star supply transformer allows the 400V unit to operate from other supply voltages.

### RS232 and T&R Link

An RS232 port is provided to allow connection of a printer or PC and the T&R link output provides a phase lock reference for a DVS3 mk2 phase-shifting voltage source.

### USB data storage

All test results from the 200A-3PH mk2 can be stored to a USB memory key. All results are time and date-stamped, and can include a user defined comment. All saved results can be viewed on the control unit display or on a PC.

### Timing System

Range	0-999.999s	Resolution	1ms
Accuracy	0.01%rdg+2d (+4d current operated mode)		

The contact circuit has an open circuit voltage of 24Vdc and a short circuit current of 20mA. Each contact circuit will auto-select for normally open or normally closed contacts. A DC voltage of 24-240Vdc may also be used to trigger either timer channel. The output is automatically switched off at the end of the test to safeguard the relay under test.

The following functions are provided:

Mode	Timer Start	Timer Stop
Internal start	Press 'ON'	Contact 1
Single contact	Contact 1	Contact 1
Dual contact	Contact 1	Contact 2
Current operated	Current > 20% of range	Current < 20% of range

Pulse mode is used for setting the current level in devices sensitive to heating, and allows current to be injected for 500ms and the current recorded.

Current operated mode operates on one output phase (selectable).

### Temperature Range

Storage	-20°C to 60°C	Operating	0°C to 45°C
---------	---------------	-----------	-------------

### Accessories

Operating manual, output lead set, mains lead, spare fuse set, USB memory key, and USB keyboard.

### Optional Accessories

Delta-Star supply transformer, printer, T&R Link lead.

### Dimensions

315 x 550 x 300mm

### Weight

33kg

Including handle and corner protectors

### Optional Delta-Star Supply Transformer

The optional delta-star supply transformer allows operation from 115V, 230V, 400V, and 440V 3 wire supplies, selected by a switch on the unit. An auxiliary single phase output is also provided to supply power to a DVS3 mk2 voltage source.

Input: 115V, 230V, 400V,  
440V  $\pm 10$  3 wire  
3 phase 1500VA max

3 $\phi$  output: 400V 4 wire 600VA  
1 min on/15 min off

1 $\phi$  output: 230V 300VA  
5 min on/15 min off





# 1200A-3PH 3 Phase Current Injection System

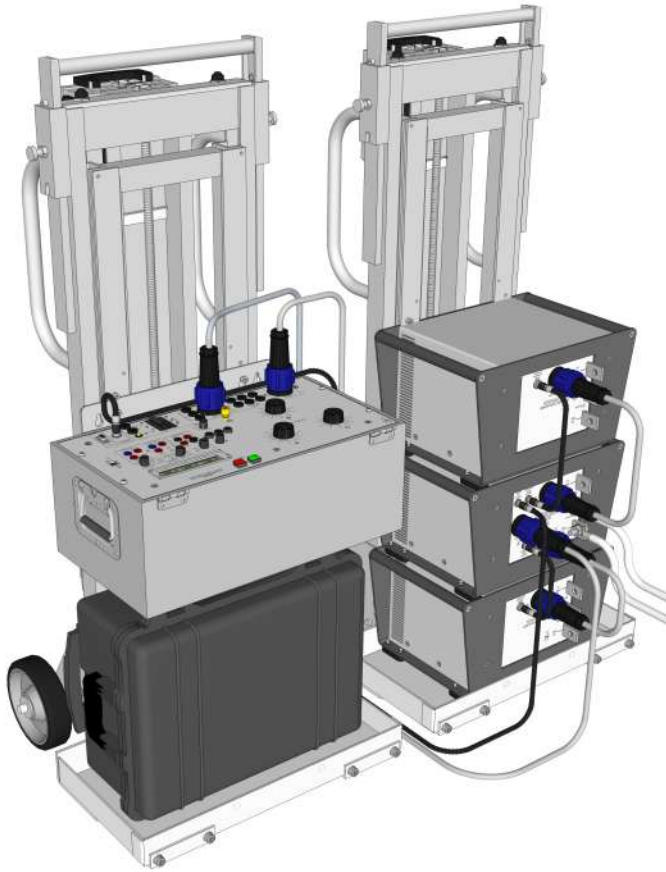

## Features

- Clear and simple user interface
- 3 phase current output
- 0-1200A per phase output current
- True RMS digital metering
- Memory ammeter
- Multi-function timing system
- Auxiliary metering input
- Large back-lit liquid crystal display
- Thermal and over-current protection
- Portable on battery powered stair climbing trolleys
- Maximum power output 13kVA

An auxiliary metering input is provided and can measure voltage, current, frequency, and the phase between any of the current outputs and an external voltage or current.

The 1200A-3PH is a three phase injection system providing commissioning and maintenance engineers with a flexible system for testing protective systems. It has an easy to understand panel layout and a simple user interface. The status of every function can be seen at a glance, and there are no complex menus to navigate.

The timing system is very flexible without compromising ease of use, allowing trip times, reset times and reclose times to be quickly measured to a high degree of accuracy. Two independently isolated contact inputs are provided, and the timing system may also be used as a stand-alone timer.

Each loading unit has two output taps to allow for a range of load impedance. Each phase is isolated and can be configured to either give a maximum of 1200A at 3.5V or 600A at 7V. Three true RMS metering ranges are provided, allowing the full scale of the meter and trip level to be set independently of the selected output.

The 1200A-3PH can be use to test many single and three phase devices including:

- Over and under current relays
- IDMT relays
- Auto-reclosers
- Time delay relays
- Earth fault relays
- Miniature circuit breakers
- Power relays
- Tripping relays
- Thermal relays

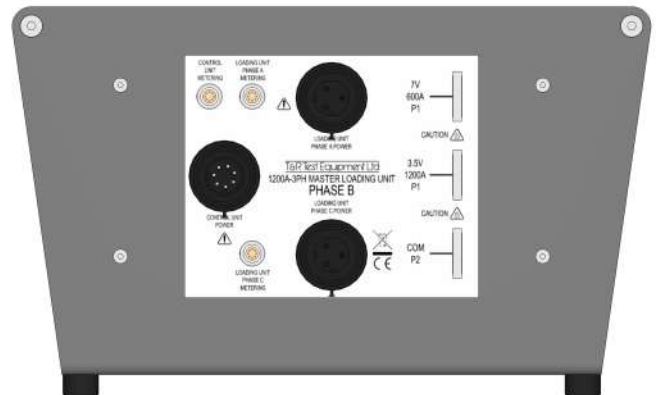
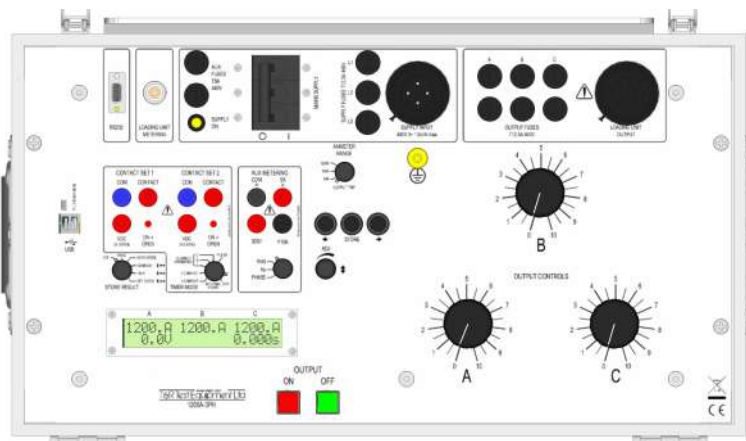

## 1200A-3PH Specification

### Loading Unit Ratings

The AC Output current is metered by a true RMS memory ammeter (acquisition time 200ms) with a liquid crystal display. The current metering has 3 ranges 60A, 500A and 1200A. The main output on the loading unit has two taps, allowing the selection of output voltages up to 7V and output currents up to 1200A.

Range	Continuous	5 minutes	1 minute	20s
3.5V	350A	600A	1000A	1200A
7V	175A	300A	500A	600A

The above intermittent on times must be followed by an off time of 15 minutes, and are based on an ambient temperature of 25°C.

### Metering

The output is metered by a digital true RMS system with a memory ammeter - whenever the timer stops and the output is switched off, the current reading is held on the display. The currents for each phase are displayed simultaneously.

Range	Resolution	Trip current	Accuracy
60.00A	0.01A	63A	±0.6%rdg+5d
500.0A	0.1A	525A	±0.6%rdg+5d
1200A	1A	1260A	±0.6%rdg+5d

A current trip is automatically set to 105% of full scale of the current metering range to protect the device under test.

### USB Storage of Results

All test results from the 1200A-3PH can be stored to a USB memory key. All results are time and date-stamped, and can include a user defined comment. All saved results can be viewed on the control unit display or on a PC.

In addition to this the 1200A-3PH can store a .BMP file of the waveform to the USB key.

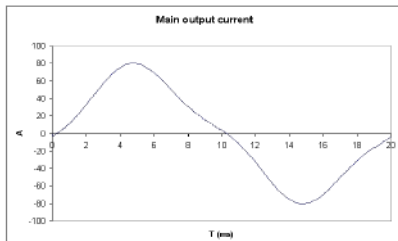

### Auxiliary Metering Inputs

An auxiliary metering input is provided which is able to measure RMS voltage or current. In addition the frequency of the external input may be measured, and the phase measured between any of the phase outputs and the auxiliary metering input.

Setting	Range	Resolution	Accuracy
Volts AC	270.0V	0.1V	±0.7%rdg+5d
Amps AC	5.000A	1mA	±0.7%rdg+5d
Phase ±180°	0.1°		±3°
Frequency	20-1000Hz	0.1Hz	±0.2%rdg+1d

The current input is protected by a F6.3A fuse.

### Supply Requirements

440V±10% 50/60Hz 3ph (3P+E) 1300VA

### RS232

An RS232 port is provided to allow connection to a printer or PC.

### Timing System

Range	0-999.999s	Resolution	1ms
Accuracy	0.01%rdg+2d (+4d current operated mode)		

The contact circuit has an open circuit voltage of 24VDC and a short circuit current of 20mA. Each contact circuit will auto-select for normally open or normally closed contacts. A DC voltage of 24-240VDC may also be used to trigger either timer channel. The output is automatically switched off at the end of the test to safeguard the relay under test.

The following functions are provided:

Mode	Timer Start	Timer Stop
Internal start	Press 'ON'	Contact 1
Single contact	Contact 1	Contact 1
Dual contact	Contact 1	Contact 2
Current operated	Current > 10% of range	Current < 10% of range

Pulse mode is used for setting the current level in devices sensitive to heating, and allows current to be injected for 200ms and the current recorded.

Current operated mode operates on one output phase (selectable).

### Protection and Safety

The unit is protected by electronic over current and duty cycle trips on the outputs, thermal monitoring on the power components, and fuses on the input and regulator. An earth terminal is provided for connection to a local earth. The unit is designed to comply with BSEN61010 and is CE marked.

### Lead Set Specifications

The 1200A-3PH is supplied with a lead set in a plastic case including:

- 1 x 5m mains lead
- 1 x 5m power interconnection lead to connect control unit to master loading unit
- 2 x 1m power interconnecting leads to connect master to slave loading units.
- 1 x 5m metering interconnecting lead to connect control unit to master loading unit
- 2 x 1m metering interconnecting leads to connect master loading units to slave loading units
- 6 x 3m 95mm<sup>2</sup> output leads terminated in M12 Crimps.
- 1 x 5m 2 core timer lead terminated in 4mm plugs

\*Additional leads can be supplied

### Temperature Range

Storage	-20°C to 60°C	Operating	0°C to 45°C
---------	---------------	-----------	-------------

### Dimensions

	Dimensions	Weight
Loading unit	450 x 275 x 370mm	44kg
Control Unit	315 x 550 x 300mm	35kg
Trolley	610 x 450 x 1450mm	

### Accessories

Operating manual, spare fuse set, USB memory key, USB keyboard, lead set case. 2 battery operated stair climbing trolleys with spare batteries and chargers.

# DVS3 mk2 Relay Test System



## Features

- 3- $\phi$  Voltage output from 1- $\phi$  supply
- 0-133V  $\phi$ -N output voltage  
292V  $\phi$ -N with VT box
- 45VA/phase maximum output
- Variable Frequency 40-999.9Hz
- Phase shift  $\pm 180.0^\circ$
- Multi-function timing system
- Ideally suited to testing G59 schemes
- Step change of phase and df/dt
- Large back-lit liquid crystal display
- Automatic mains voltage selection

The DVS3 mk2 is the new, lighter, higher power version of the T&R DVS3, offering three times the output power of the original DVS3. The exceptionally easy to understand user interface of the DVS3 is retained, allowing simple testing of complex voltage and loss of mains protection systems.

Equally at home in a commissioning, maintenance, or laboratory environment, the DVS3 mk2 is a truly flexible system. The DVS3 mk2 has been designed using the latest digital technology to generate a highly stable and accurate output with very low distortion. Each phase output is individually adjustable for voltage

The DVS3 mk2 is ideally suited to testing G59 protection, including loss of mains protection. Vector surge and df/dt (ROCOF) relays may be simply tested and timed, as can other protection requiring one to three voltages, including:

- Under and over frequency relays
- Under and over voltage relays
- Synchronising relays
- df/dt & ROCOF relays
- Vector surge relays
- Transducers

*The display on the DVS3 is back-lit and exceptionally clear. Menu options on the left are selected by dedicated buttons on the panel next to the display, allowing immediate access to adjust voltage, phase and frequency. Phase to phase and phase to neutral voltages are both shown on the display, along with frequency and phase information. A graphical vector diagram is shown, as is the state of the two contact inputs.*

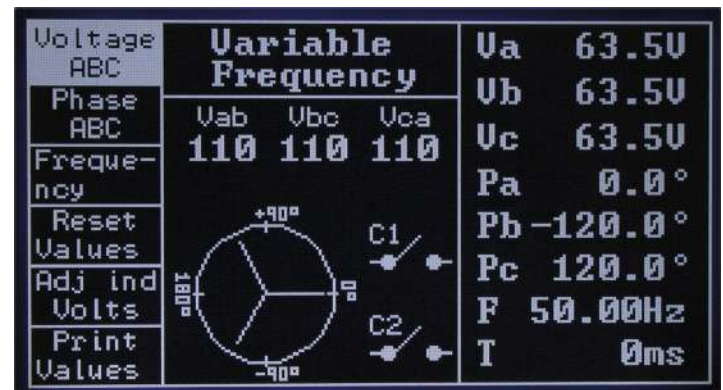

and phase angle. In addition, full control of frequency is available. Step changes of any quantity may be generated with automatic timing of the response of the relay under test.

The unit is controlled by a simple user interface with context sensitive menus. Values may be either typed in at the keypad or smoothly varied using a digital potentiometer.

In conjunction with a current source (such as the 200ADM-P), the DVS3 mk2 can be used to test protection requiring current injection with a phase-shiftable voltage including:

- Directional relays
- Distance protection
- Power transducers

## DVS3 mk2 Specification

### Output

The output of the DVS3 mk2 has four 4mm safety sockets for phases A, B, C, and neutral. The neutral connection may be omitted for a delta connection.

Voltage	0-133VAC phase-neutral 0-230Vac phase-phase
Current (continuous)	200mA at 133V, 120mA at 0.1V*
Current (5min on/ 15min off)	335mA at 133V, 200mA at 0.1V*
Voltage resolution	0.1V phase-neutral
Phase rotation	$\pm 180^\circ$
Voltage accuracy	$\pm 0.3\% \text{rdg} + 3\text{d}$

\*The current trip drops linearly between maximum and minimum output voltage. All output ratings are based on an ambient temperature of 25 °C.

### Timing System

The timing system on the DVS3 mk2 is flexible and transparent in operation. Step changes of any quantity may be generated by typing in value using the keypad. Entering a value in this way automatically resets and starts the timer when the change is applied. The timer then stops on a change of state of either contact input. More complex timing functions are handled by the PF-F-PF mode.

Two contact inputs are provided, both of which have LEDs and a mimic on the display to show the contact state. The contact inputs auto-select for normally open or normally closed contacts. A DC voltage can also be used to trigger the timer using the Vdc contact.

Timer resolution	1ms
Timer full scale	999.999s
Timer accuracy	$\pm 0.01\% \text{rdg} + 2\text{d}$
Contact O/C voltage	24V
Contact S/C current	20mA
VDC input range	24-240Vdc

### Protection and Safety

The DVS3 mk2 is CE marked and is designed to meet the requirements of BS EN61010. The outputs are protected by overcurrent and thermal trips, and the contact inputs are protected by PTC thermistors. The phase lock current input is fuse protected, and the voltage input is impedance protected. An earth terminal is provided for connection to a local earth.

### Supply Requirements

115V/230V $\pm 10\%$  auto-selecting, 45-65Hz 1ph 425VA max

### Temperature Range

Storage -20 °C to 60 °C      Operating 0 °C to 45 °C

### Lead Set Specifications

1 x 3m 4 core output lead terminated in 4mm plugs  
1 x 3m 2 core timer lead terminated in 4mm plugs

### Dimensions

560 x 456 x 265mm

### Weight

13kg

### Accessories

Output lead set, mains lead, spare fuse set, operating manual.



## Modes of Operation

### Variable Frequency Mode

This mode allows full control of frequency, voltage and phase. Each voltage and phase can be controlled together or independently. All parameters are continuously variable using the adjust control, and step changes of any value. The timer automatically resets and starts when a step change of value is entered, and stops if either contact input changes state. Step changes of phase for testing Vector Surge relays are easily generated in this mode.

Frequency resolution	0.01Hz 40.00-99.99Hz 0.1Hz 100.0-999.9Hz
Frequency accuracy	$\pm 0.01\% \text{rdg} + 1\text{d}$
Phase resolution	0.1°
Phase accuracy	$\pm 0.3^\circ$ phase to phase

### Phase Lock Mode

The frequency and phase of the output are controlled by an external reference in phase lock mode. The reference may be the mains supply to the DVS3 mk2, an external voltage, or an external current. This mode allows testing of directional and distance protection in conjunction with an external current source.

Phase lock range	45-65Hz
External voltage ref.	20-250V AC
External current ref.	0.2-5A AC
Phase resolution	0.1°
Phase accuracy	$\pm 0.3^\circ$ phase to phase $\pm 3.0^\circ$ reference to output

### df/dt and ROCOF (Rate Of Change Of Frequency)

Loss of mains protection often takes the form of a df/dt relay, sensitive to the rate of change of frequency over time. The DVS3 mk2 is able to generate a swept frequency output with accurate rates of change of frequency between preset frequencies. The rate of change may be continuously varied to find the relay setting or stepped to time the relay. The output may be set to either sweep continuously or generate single sweeps with timing.

Frequency range	45.00-65.00Hz
Default sweep range	49.75-50.25Hz (50Hz supply) 59.75-60.25Hz (60Hz supply)
Rate of change range	0.010-3.000Hz/s

### Pre-fault - Fault - Post-fault Mode

PF-F-PF mode allows extra flexibility in testing complex timed events or several sets of values must be applied to a relay in turn. This mode allows three sets of values to be set in advance (pre-fault, fault, and post-fault values). The DVS3 mk2 may be set to switch from one state to the next on a change of contact or after a specific time. In addition, the timer may be set to start or stop on any one of the state changes of a change of contact state. This mode allows frequency, phase and voltage to be changed simultaneously if required.

### Optional Accessories

Printer, leadset carry case.

# 50A-3PH mk2

# DVS3 mk2

- 3 $\phi$  current
- 0-50A per phase
- True RMS metering
- Multi-function timing system
- Auxiliary metering input
- Compact & portable
- 220V or 400V 3 $\phi$  supply options



- 3 $\phi$  voltage
- 0-133V $\phi$ -N 292V $\phi$ -N with VT box
- $\pm 180^\circ$  phase shift
- 40-999.9Hz
- 45VA/phase
- Multi-function timing system
- Compact & portable
- Single phase supply
- G59 & G59/2/3 Relay



## Relay Test System

T&R Test Equipment is renowned for its rugged, reliable and innovative relay test equipment solutions. The DVS3 mk2 voltage source and 50A-3PH mk2 current source provide the commissioning and maintenance engineer with a flexible 3 phase relay test system at a realistic price.

The units may either be used together to test directional and distance protection, or individually to test single and three phase voltage (DVS3) and current (50A-3PH) relays.

The DVS3 also excels in testing G59 embedded generation protection, including voltage, frequency, vector surge and df/dt (ROCOF) relays.

The DVS3 runs from a 230V single phase supply, and the 50A-3PH from a 400V 4 wire, 3 phase supply. An optional delta-star supply converter is available, allowing the DVS3 and 50A-3PH to use a 115V, 230V, 400V or 440V 3 phase 3 wire supply.

### Applications

#### 50A-3PH mk2

- Over and under current relays
- Miniature circuit breakers
  - Earth fault relays
  - Auto-reclosers
  - IDMT relays

#### 50A-3PHmk2 +DVS3 mk2

- Directional overcurrent relays
- Distance protection relays
  - Phase angle relays
  - Power transducers
  - Power relays

#### DVS3 mk2

- Under and over frequency relays
- Under and over voltage relays
  - df/dt & ROCOF relays
  - Synchronising relays
  - Vector surge relays

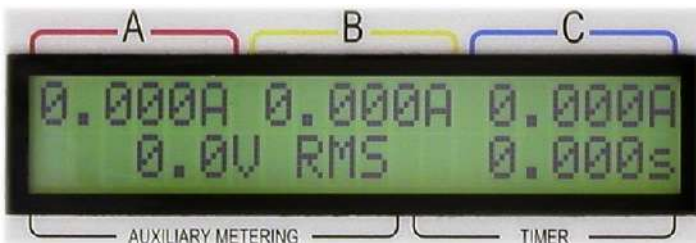

The displays on both the 50A-3PH mk2 and DVS3 mk2 are large, clear and easy to read. Both are back-lit liquid crystal displays, and show all operating parameters of the units at all times.

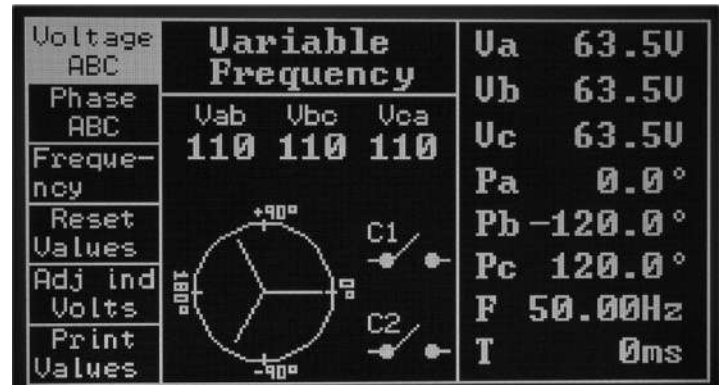

## 50A-3PH mk2 Applications

### Overcurrent/IDMT relays

The 50A-3PH mk2 is ideally suited to testing single and three phase overcurrent relays. Testing is simplicity itself:

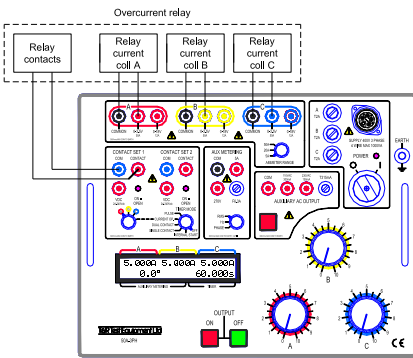

Set the timer mode to "off" and switch the output on.

Set the required currents for each phase, and switch the output off.

Set the timer mode switch to "Internal start", and press the "on" pushbutton.

The timer will reset, start and current injection commences.

When the relay contacts change state, the timer stops and the current is switched off. All three currents are held on the display from the moment the relay tripped, and displayed with the trip time.

### Miniature Circuit Breakers and Trips

Testing devices with no auxiliary contacts is no problem. The 50A-3PH mk2's current operated mode starts and stops the timer from the rise and fall of the output current.

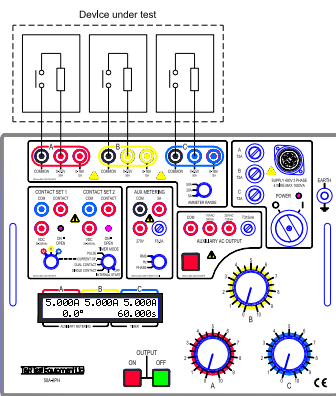

Set the timer mode to "off" and switch the output on.

Set the required currents for each phase, and switch the output off.

Select the "Current operated" timer mode, and press the "on" pushbutton.

The timer will reset, start and current injection commences.

When the breaker trips, the timer stops. All three currents are held on the display from the moment the relay tripped, and displayed with the trip

### Auto-reclosing relays

The 50A-3PH mk2's flexible timing system easily handles timing of auto-reclosing devices. Sensitivity of the contacts to changes of state rather than open or closed simplifies the setup for all timing functions, and this type of relay in particular.

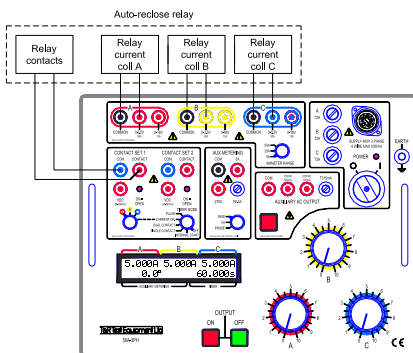

Set the timer mode to "off" and switch the output on. Set the required currents for each phase, and switch the output off.

Set the timer mode switch to "Single contact", and press the "on" pushbutton.

The timer will reset, and current injection starts. When the relay contacts change state for the first time, the timer starts and the current is switched off. All three currents are held on the display. When the relay recloses, the timer stops and displays the reclose time.

When the relay recloses, the timer stops and displays the reclose time.

## Timing

### 50A-3PH mk2

The two-contact timing system on the 50A-3PH mk2 is very flexible, and geared to the timing of current relays. Two sets of isolated contacts sensitive to changes of state are linked to an easy to understand mode control. The following modes are provided:

**Internal start:** The timer starts when the output is switched on, and stops when contact set 1 (CS1) changes state.

**Single contact:** The timer starts on the first change of CS1, and stops on the second change.

**Dual contact:** The timer starts on a change of state on CS1, and stops on a change of CS2.

**Current operated:** The timer starts when the output current exceeds 20% of the selected ammeter range, and stops when it falls below 20%.

**Pulse mode:** The output is switched on for 500ms.

In each case, the timer is reset and armed when the output is switched on.

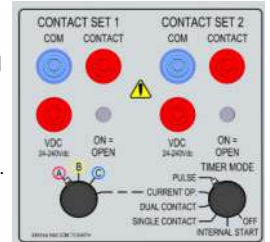

### Directional over-

When used together, the DVS3 mk2 and 50A-3PH mk2 are able to test many types of complex protection requiring three voltage and three currents. Testing three phase directional overcurrent relays is well within the capabilities of this system. Phase A of the output current is used to provide a phase reference to the DVS in this configuration. Phase A of the DVS output voltage is then in phase with current A when 0° is shown on the DVS display. To test the relay, first select phase lock mode-external lock on the DVS and switch on the output.

Switch on the 50A-3PH mk2 output with the timer in the "off" position, and increase the current on each phase to the setting current of the relay (1A on a 1A relay). This sets the current reference for finding the restraint angle of the relay. The restraint angle of the relay may now be found by rotating the voltage vectors on the DVS.

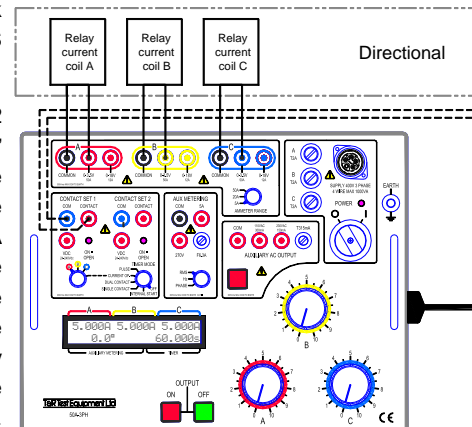

DVS3 mk2

The DVS3 mk2 timer is transparent in operation, triggered by any step change of output value. If the relay contacts are connected, you'll be able to time the relay without realising you have!

To generate a step change of frequency on the DVS3 output, just type a new value on the keypad. When you press enter, the frequency steps from the old value to the new value, and the timer resets and starts. A change of state on the contacts will then stop the timer.

The system is very flexible, and is triggered from step changes of voltage, phase and frequency. In each case, the timer is reset and started when a new value is typed in and the enter key pressed.

More complex timing tasks can be undertaken using the pre-fault, fault, post-fault mode.



current relays

Mimics of the relay contacts are shown next to the phase on the display to make this easy. The graphical vector diagram makes finding the approximate restraint angle simple, and the text display gives an accurate result.

To time the relay, set the current to the desired level on the 50A-3PH mk2, switch the output off, and select "internal start" timer mode. When the "on" pushbutton is pressed, the timer resets and starts and current injection commences.

When the relay contacts change state, the timer stops and the current is switched off. All three currents are held from the moment the relay tripped, and displayed with the trip time.

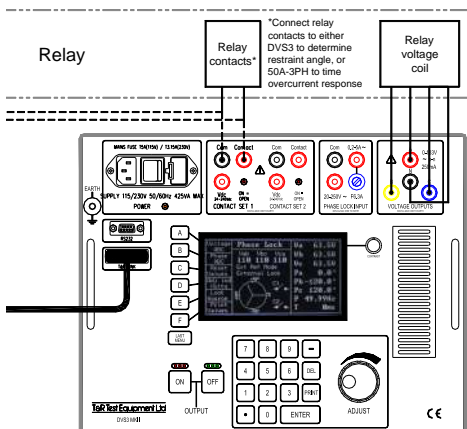

DVS3 mk2 Applications

Over voltage relays

Operating points and times of under and over voltage relays may be found with ease using a DVS3 mk2. This example uses a 63.5V relay.

Enter the relay operating voltage using the keypad (press 63.5 and ENTER to set 63.5V for phase A, B, and C together). Switch the output on.

Increase the output voltage using the "adjust" knob until the relay trips. Record the voltage—this is the operating point of the relay. Set the DVS3 mk2 back to 63.5 using the keypad.

Enter a voltage that will trip the relay using the keypad (e.g. 70V). When ENTER is pressed, the timer resets and starts, and the output voltage changes. When the relay operates, the timer stops.

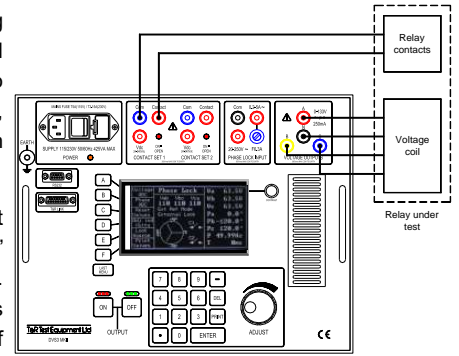

df/dt relays

Rate of Change of Frequency (ROCOF) or df/dt relays are frequently used in loss of mains protection in embedded generation schemes. The DVS3 makes light work of an otherwise difficult test.

The ROCOF mode on the DVS3 allows the output frequency to be swept between minimum and maximum values at a programmable rate. The frequency may be continuously swept, or single sweeps applied. When single sweeps of frequency are used, the timer automatically starts when the sweep starts, allowing the response of a df/dt relay to be timed.

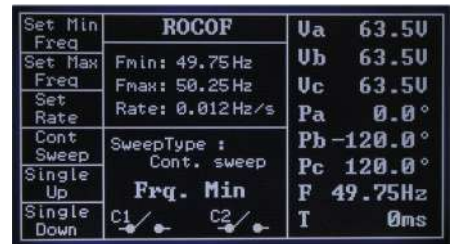

To test a ROCOF relay, set the desired minimum and maximum frequencies, and gradually increase the rate of change until the relay trips. Greater accuracy may be achieved using the single sweep mode; many ROCOF relays do not have the same sensitivity to rising and falling changes of frequency.

Vector surge relays

Vector surge (relays sensitive to changes of phase with time) may be easily tested with the DVS3. In variable frequency mode step phase changes may be generated at any frequency between 40 and 1000Hz.

To generate a phase step on all three phases, first enter phase adjustment mode by pressing "Phase ABC". start with phase A at 0°, and enter a new value (e.g. 6° by typing 6 ENTER). When enter is pressed, the output steps to 6°, creating a +6° phase step. Setting a phase angle of zero will then result in a phase step of -6°. In this way a series of increasing positive and negative phase steps can very easily be generated to find the operating point of a vector-surge relay.



## 50A-3PH mk2 Specification

Please refer to the 50A-3PH mk2 and DVS3 mk2 data sheets for full specifications

The main output on the unit has two taps, allowing the selection of output voltages up to 18V and output currents up to 50A.

Range	Continuous	5 minutes	1 minute
3.5V	16A	32A	50A
18V	4A	8A	12A

The above intermittent on times must be followed by an off time of 15 minutes, and are based on an ambient temperature of 25°C.

### Metering

The output is metered by a digital true RMS system with a memory ammeter - whenever the timer stops and the output is switched off, the current reading is held on the display.

Range	Resolution	Trip current	Accuracy
5.000A	0.001A	5.25A	±0.6%rdg+5d
20.00A	0.01A	21A	±0.6%rdg+5d
50.00A	0.01A	52.5A	±0.6%rdg+5d

A current trip is automatically set to 105% of full scale of the current metering range to protect the device under test.

### Auxiliary Metering Inputs

An auxiliary metering input is provided which is able to measure RMS voltage or current. In addition the frequency of the external input may be measured, and the phase measured between any of the phase outputs and the auxiliary metering input. The current input is fuse protected.

	Range	Resolution	Accuracy
Volts AC	270.0V	0.1V	±0.7%rdg+5d
Amps AC	5.000A	1mA	±0.7%rdg+5d
Phase	±180°	0.1°	±3°
Frequency	20-1000Hz	0.1Hz	±0.2%rdg+1d

### Auxiliary Output

A single phase isolated auxiliary output of 110V 300mA or 230V 110mA (33VA) is provided on the 50A-3PH. An optional external unit is available to convert this output to variable 0-110/220VAC or 0-150/300Vdc.

### Timing System

Range	0-999.999s	Resolution	1ms
Accuracy	0.01%rdg+2d (+4d current operated mode)		

Each contact circuit auto-selects for normally open or normally closed contacts. A DC voltage may also be used to trigger the timer. The output is automatically switched off at the end of the test.

Mode	Timer Start	Timer Stop
Internal start	Press 'ON'	Contact 1
Single contact	Contact 1	Contact 1
Dual contact	Contact 1	Contact 2
Current operated*	Current > 10% of range	Current < 10% of range
Pulse mode	Current injected for 600ms	

\*Current operated mode operates on one output phase (selectable).

### Supply Requirements

The unit is available for operation from a 400V 4 wire supply or 220V 3 wire supply. The optional delta-star supply transformer allows the 400V unit to operate from 115V, 230V, 400V and 440V 3 wire supplies.

Supply : 400V\*-10%+14% or 220V\*-6%+14% 50/60Hz 3ph 1000VA

\*Specify at time of ordering

### Dimensions

560 x 456 x 265mm

### Weight

24.9kg

### 50A-3PH mk2 and DVS3 mk2

Contact O/C voltage	24V	Contact S/C current	20mA
Vdc input range	24-240Vdc		

### Accessories

Both units are supplied with an operating manual, spare fuses and mains lead

## DVS3-mk2 Specification

	Range	Resolution	Accuracy
Voltage	0-133VAC p-n	0.1V p-n	±0.3%rdg+3d
Var. frequency	40.00-99.99Hz	0.01Hz	±0.01%rdg+1d
	100.0-999.9Hz	0.1Hz	±0.01%rdg+1d
PL frequency	45.00-65.00Hz	0.01Hz	±0.01%rdg+1d
Phase rotation	±180°	0.1°	±0.3° p-p
			±3.0° ref to o/p
Timer	0-999.999s	1ms	±0.01%rdg+2d
O/P rating	200mA at 0.1V	335mA at 133V	5 min on/15 off

### Timing System

The timing system on the DVS3 mk2 is flexible and transparent in operation. Step changes of any quantity may be generated by typing in value using the keypad. Entering a value in this way automatically resets and starts the timer when the change is applied. The timer then stops on a change of state of either contact input. More complex timing functions are handled by the PF-F-PF mode.

### Variable Frequency Mode

This mode allows full control of frequency, voltage and phase. The voltage and phase may be controlled individually for each phase or for all three phases together. All parameters are continuously variable using the adjust control, and step changes of any value may be generated by typing the required value on the keypad.

### Phase Lock Mode

The frequency and phase of the output are controlled by an external reference in phase lock mode. The reference may be the mains supply to the DVS3 mk2, an external voltage, or an external current. This mode allows testing of directional and distance protection in conjunction with an external current source. The unit may be automatically phase locked to the 50A-3ph through the T&R Link lead.

Phase lock range	45-65Hz
External reference	Voltage 20-250Vac, Current 0.2-5A AC

### df/dt and ROCOF (Rate Of Change Of Frequency)

The DVS3 mk2 is able to generate a swept frequency output with accurate rates of change of frequency between preset frequencies. The rate of change may be continuously varied to find the relay setting or stepped to time the relay. The output may be set to either sweep continuously or generate single sweeps with timing.

Frequency range	45.00-65.00Hz
Default sweep range	49.75-50.25Hz (50Hz supply)
Rate of change range	0.010-3.000Hz/s

### Pre-fault - Fault - Post-fault Mode

PF-F-PF mode allows extra flexibility in testing where complex events must be timed or several sets of values must be applied to a relay in turn. This mode allows three sets of values to be set in advance (pre-fault, fault, and post-fault values). The DVS3 mk2 may be set to switch from one state to the next on a change of contact or after a specific time. In addition, the timer may be set to start or stop on any one of the state changes of a change of contact state. This mode allows frequency, phase and voltage to be changed simultaneously if required.

### Supply Requirements

115V±10%/230V±10% auto-selecting. 45-65Hz, 1ph, 425VA max

### Dimensions

560 x 456 x 265mm

### Weight

13kg

### Protection and Safety

The DVS3 mk2 and 50A-3PH mk2 are CE marked and designed to meet the requirements of BS EN61010. An earth terminal is provided for connection to a local earth.

### Temperature Range

Storage -20°C to 60°C Operating 0°C to 45°C



# 750ADM-H mk2

# Current Injection Systems



## Features

- Primary injection up to 750A
- 4V output\*
- 16V 40A output for secondary injection
- True RMS memory ammeter with single cycle capture
- Multi-function timing system
- Large back-lit liquid crystal display
- Thermal and over-current protection
- Automatic switch-off at end of test
- Compact and portable
- Automatic mains voltage selection\*

\*See specifications overleaf

T&R Test Equipment is a market leader in the field of current injection equipment. The range includes secondary injection units with 100A output capability up to 6000A primary injection systems. All have true RMS metering, a flexible timing system, and an easy to understand user interface.

The 750ADM-H mk2 is a compact, rugged primary current injection system with a 750A output capability. The 750ADM-H mk2 has a maximum no load output voltage of 5V. The unit is ideally suited to all low power primary injection tasks requiring up to 750A for short periods.

Unit type	Max. power	Max. current
750ADM-H	3kVA	750A
PCU1-SP + NLU5000	11.5kVA	3kA 5min/5kA 40s
PCU2 mk5 + LU6000	20kVA	6kA

Where higher currents and powers are required for primary injection, 11kVA and 20kVA primary injection systems are available. The PCU1-SP and PCU2 mk5 systems have separate control and loading units, allowing a wide range of load conditions to be covered with different loading units.

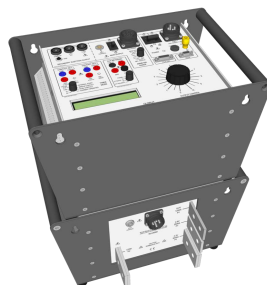

PCU1-SP and NLU5000

The unit has two outputs, allowing injection of currents as low as a few hundred milliamps and up to 750A. Voltages up to 16V are available on the 40A output, allowing higher impedance trips to be tested. Four true RMS metering ranges are provided, allowing the full scale of the meter and trip level to be set independently of the selected output. The metering has a capture time of less than 20ms, allowing the rms of a single cycle to be accurately measured. Industry standard connectors are used on all inputs and outputs for convenience, reliability and safety.

The 750ADM-H mk2 is comprehensively protected by electronic overcurrent and thermal trips.

The timing system is very flexible without compromising ease of use, allowing trip times, reset times and reclose times to be quickly measured to a high degree of accuracy. Two contact inputs are provided, each of which may be triggered by a volt-free contact or a DC voltage. The contact inputs auto-sense for normally open or normally closed contacts.

The 750ADM-H mk2 can be used to test many devices including:

- Circuit breakers
- Primary injection of over-current relays
- Auto-reclosers
- MCB's
- CT ratio (with external meter for secondary current)

## 750ADM-H mk2 Specification

### Main Output

The main output on the unit has two taps, allowing the selection of output voltages up to 16V and output currents up to 750A. The unit operates at slightly reduced ratings when operating from a 115V supply.

	115V	230V	
750A Output	Open circuit voltage	3.5V	5.0V
	Voltage at 500A	2.8V	4V
	Continuous current	125A	125A
	5 min on	250A	250A
	1 min on	440A	500A
	Max current	500A	750A
	Max current on time	10s	20s
	Open circuit voltage	10V	16V
	Full load voltage	7.5V	10V
	Continuous current	10A	10A
1 min on	40A	40A	
40A Output			

### Metering

The output is metered by a digital true RMS system with a memory ammeter - whenever the output is switched off, the current reading is held on the display.

Range	Resolution	Trip current	Accuracy	Capture time
20.00A	0.01A	21A	±0.5%rdg+5d	20ms
50.00A	0.01A	53A	±0.5%rdg+5d	20ms
200.0A	0.1A	210A	±0.5%rdg+5d	20ms
750A	1A	788A	±0.5%rdg+2d	20ms

A current trip is automatically set to 105% of full scale of the selected metering range to protect the device under test.

### Timing System

Range	0-999.999s/9999.99s/99999.9s auto-ranging
Resolution	1ms/10ms/100ms
Accuracy	±0.01%rdg+2d (all modes except current operated) ±0.01%rdg+4d (current operated mode)

The contact circuits have an open circuit voltage of 24VDC and a short circuit current of 20mA. Each contact circuit will auto-select for normally open or normally closed contacts. A DC voltage of 24-240VDC may also be used to trigger either timer channel.

The following functions are provided:

Mode	Timer Start	Timer Stop
Off	Timer inactive	Timer inactive
Internal start	Press 'ON'	Contact 1
Single contact	Contact 1	Contact 1
Dual contact	Contact 1	Contact 2
Current operated	Current > 20% of range	Current < 20% of range

The output is automatically switched off at the end of the test to safeguard the relay under test.

### RS232

An RS232 port is provided to allow connection to a PC or a printer.

### T&R Link

The T&R Link allows a T&R DVS3 mk2 voltage source to phase lock to the 750ADM-H current.

### Supply Requirements

Auto-selecting	
115V±10% 50/60Hz 1ph	1900VA max
230V±10% 50/60Hz 1ph	3900VA max

### Temperature Range

Storage	-20°C to 60°C	Operating	0°C to 45°C
---------	---------------	-----------	-------------

### Dimensions

560 x 456 x 265mm

### Weight

27.4kg

### Accessories

Operating manual, mains lead, and carrying strap.

### Optional 750ADM-AL Lead Set specifications

A range of output leads are available to complement the 750ADM-H. The standard 750ADM-AL lead set is 3m long, recommended for use with a 230V Supply. A 1.5m lead set is also available, and is recommended when operating from a 115V supply. The leads consist of double insulated 95mm<sup>2</sup> welding cable terminated in Dinse high current connectors at the 750ADM end and high current welding clamps at the load end.



Low current timer leads are also included with the lead set:

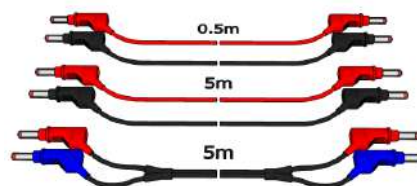

The 3m lead set weighs 9.8kg including high current leads and timer leads.

### Protection and Safety

The unit is protected by electronic over current and thermal trips on the outputs, and circuit breakers on the input and power circuit. An earth terminal is provided for connection to a local earth when testing in a substation environment. The unit is designed to comply with BSEN61010, and is CE marked.



# PCU1-SP mk2

## Primary Current

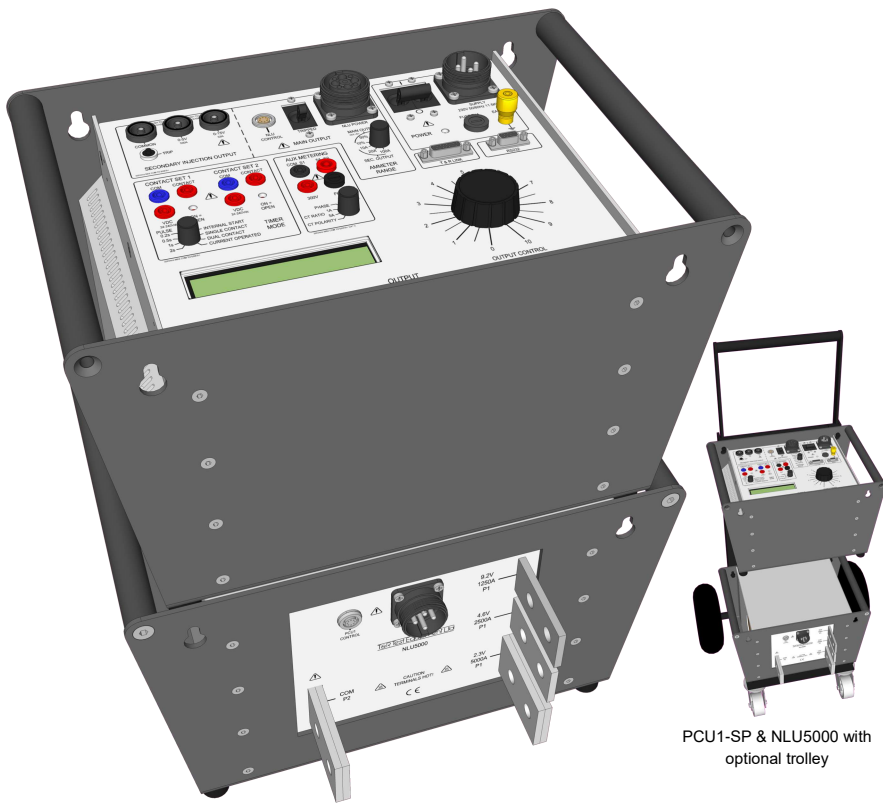

PCU1-SP & NLU5000 with optional trolley

### Features

- 5kA maximum output current (higher overload currents for 2s)
- Multi-function digital timing system
- True RMS memory ammeter with single cycle capture
- 2000A and 5000A loading units
- Three range outputs on loading units
- Rugged, compact design
- Optional trolley mounting of system
- Secondary injection up to 100A
- Direct reading CT ratio and polarity

The PCU1 series are medium powered primary current injection systems offering output currents up to 5000A. The system consists of a separate control unit containing all metering and control functions and a loading unit that provides the high current output. The PCU1-SP mk2 is ideally suited to primary current injection, stability testing and circuit breaker testing. In addition, it offers direct-reading CT ratio and polarity tests and a 100A secondary injection output. T&R also offer the higher-powered PCU2 system.

The control units are rated at 11.5kVA with a 2 second overload capability of 23kVA using pulse mode. All metering is digital and a memory facility is provided to hold the current reading when the output trips or is switched off. The PCU1 systems have a high accuracy timing system with 1ms resolution. Selection for normally open or normally closed contacts is automatic, and the status of the contacts is shown on the front panel. Timing modes are available for under and over current devices, re-closers, under and over voltage devices, current trips and circuit breakers.

Feature	PCU1-SP mk2	PCU2
Primary injection	✓	✓
Max output power	11.5kVA 40s	20kVA 5 min
Secondary injection	✓	✗
CT ratio/polarity test	✓	✗

Two loading units are available, delivering a maximum output current of 2000A or 5000A. Each loading unit has three output taps to allow for a wide range of load impedances. For example, the NLU5000 may be configured to either give a maximum current of 5000A on the 2.3V range, 2500A on the 4.6V range or 1250A on the 9.2V range.

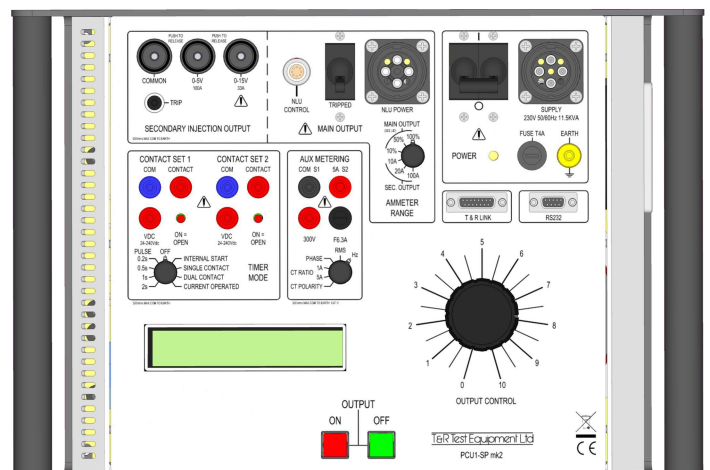

## PCU1-SP mk2 Specification

### Loading Unit Current Metering

The AC output current is metered by a true RMS memory ammeter (acquisition time 200ms) with a liquid crystal display. The current metering has 3 ranges corresponding to 10%, 50% and 100% of the maximum rating of the loading unit. In addition, a 200% metering range is enabled in pulse mode.

#### NLU2000

Range	Full scale	Resolution	Accuracy
10%	200.0A	0.1A	±0.5%rdg+5d
50%	1000A	1A	±0.5%rdg+5d
100%	2000A	1A	±0.5%rdg+5d
200%	4000A	1A	±1%rdg+5d

#### NLU5000

Range	Full scale	Resolution	Accuracy
10%	500.0A	0.1A	±0.5%rdg+5d*
50%	2500A	1A	±0.5%rdg+5d*
100%	5000A	1A	±0.5%rdg+5d*
200%	10kA	10A	±1.5%rdg+5d

\* ±1.5%rdg+5d pulse mode

### Timing System

The PCU1 systems have a flexible timing system with two contact inputs and 5 operating modes. Each contact circuit automatically selects for N/O or N/C contacts, and the status of each contact input is shown by an LED. The timing channels may also be triggered by a DC voltage between 24 and 240V.

Timer resolution	1ms
Timer full scale	999.999s
Timer accuracy	±0.01%rdg+2d (4d current mode)
Contact O/C voltage	24V
Contact S/C current	20mA
Vdc input range	24-240Vdc

Timer mode	Timer start	Timer stop
Internal Start	'On' button	Contact
Single contact	Contact 1	Contact 1
Dual contact	Contact 1	Contact 2
Current operated **	Current >20% rng	Current <20% rng
Pulse mode 0.2s *	'On button'	0.2s
Pulse mode 0.5s *	'On button'	0.5s
Pulse mode 1s *	'On button'	1s
Pulse mode 2s *	'On button'	2s
Off	Setting position	I<20% range Contact 1

**\*Pulse mode** applies current to the load for a maximum of the specified time. If contact set 1 changes state or the current drops below 20% of the metering range during the pulse time, the timer is stopped. The maximum output current is increased in pulse mode. The maximum obtainable current is set by the impedance of the test object and output leads.

**\*\*Current operated mode** is used to time circuit breakers with no auxiliary contacts. The timer is started when the current exceeds 20% of the selected metering range (e.g. 100A on the NLU5000 500A range). The timer stops when the current falls.

### Secondary Injection Output

Output Range	Continuous current	Intermittent current
0-5V	33A	5min on* 1 min on*
0-16V	10A	67A 100A 20A 30A

\*All on times must be followed by an off time of 15 minutes

Metering Range	Resolution	Accuracy	Current trip
10.00A	0.01A	±0.5%rdg+5d	10.5A
20.00A	0.01A	±0.5%rdg+5d	21A
100.0A	0.1A	±0.5%rdg+5d	100A

### Supply Requirements

230V±10%, 45-65Hz 1ph 11.5kVA max (23kVA overload for 2s)

### Control Unit Standard Accessories

Mains lead (5m), loading unit power and metering leads (5m), operating manual and spare fuses.

### Dimensions

	Dimensions	Weight
PCU1-SP	450 x 275 x 305mm	26kg
NLU2000	450 x 275 x 370mm	49kg
NLU5000	450 x 275 x 370mm	58kg

### Temperature Range

Storage -20°C to 60°C, Operating 0°C to 45°C

### Protection and Safety

The PCU1 series and loading units are CE marked and are designed to meet the requirements of BS EN61010. The system is protected by electronic trips on the outputs, circuit breakers on the mains input, and control unit output. The unit also has a duty cycle trip on the loading unit output and thermal protection.

### Optional Loading Unit Specifications

Two loading units are available to provide a range of output currents suitable for different primary injection tasks. Each loading unit has three output taps allowing current injection into a wide range of loads of differing impedances.

#### NLU5000 Loading Unit Intermittent Ratings

Output	Maximum current			
Voltage*	Cont.	5 min	1 min	40s
2.3V	1500A	3000A	4500A	5000A
4.6V	750A	1500A	2250A	2500A
9.2V	375A	750A	1125A	1250A

#### NLU2000 Loading Unit Intermittent Ratings

Output	Maximum current			
Voltage*	Cont.	5 min	1 min	40s
4V	600A	1200A	1800A	2000A
8V	300A	600A	900A	1000A
16V	150A	300A	450A	500A

\*open circuit voltage at 230V mains

### Optional Output Lead Set Specifications

Type	Length	CSA	Termination
1000NAL	1m to 5m	140mm <sup>2</sup>	Copper bar
2000NAL	1m to 5m	280mm <sup>2</sup>	Copper bar
3000NAL**	1m to 3hm	420mm <sup>2</sup>	Copper bar
5000NAL**	1m to 3m	560mm <sup>2</sup>	Copper bar

\*Output currents above 3000A require very short leads, and longer leads will restrict the maximum current available

# PCU2 mk5

# Primary Current Injection System

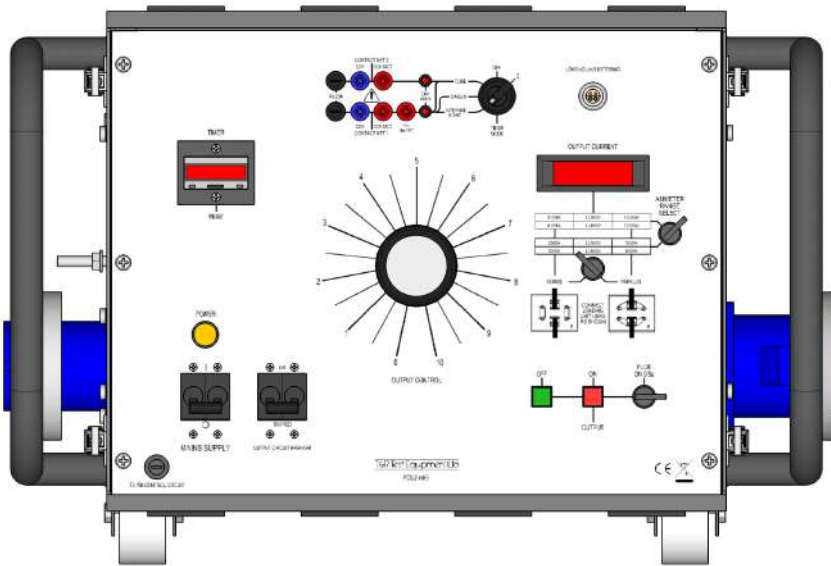

## Features

- 20kVA 5 minute output capability
- Continuously variable output
- Multi-function timing system
- Digital true RMS memory ammeter
- Bright LED displays
- Automatic switch-off at end of test
- Centralised control and metering
- Separate control and loading units
- Output up to 10kA
- Low impedance, dual-range outputs

The PCU2 Mk5 primary current injection system is ideally suited to commissioning and maintenance testing where very high currents are required. The system consists of separate control and loading units for maximum flexibility. The control unit contains all control and metering circuitry, and is linked to the loading unit by control and metering cables.

The control unit may be used with one of two loading units providing between 5000A or 6000A for 5 minutes or up to 10 or 12kA for short periods. Each loading unit has two outputs which may be connected in series or parallel for maximum flexibility. For example, the LU6000 may be configured to either give a maximum current of 3000A at 6.6V or 6000A at 3.3V.

The control and loading units are each housed in tough steel cases fitted with castors and protective lifting handles. The loading units have a small plan area to allow them to be positioned as close as possible to the test object, minimising power requirements and maximising the available current.

The PCU2 Mk5 control unit is shown here with an LU5000 loading unit. This combination may be used to inject currents of up to 5000A for 5 minutes, 8000A for 5 seconds or 10000A for 1 second.

This unit is ideally suited to all primary current injection tasks, including testing under and over current relays, circuit breakers and CT ratio testing.

The control unit is rated at 20kVA and has digital metering. A memory facility is provided on the metering to hold the current reading when the output trips or is switched off. The current is automatically switched off when the device under test trips.

A flexible timing system is provided, allowing timing tests to be carried out to a resolution of 1ms. Selection for normally open or normally closed contacts is automatic, and the status of the contacts is shown on the front panel. Timing modes are available to test under and overcurrent devices, reclosers, under and over voltage devices, current trips and circuit breakers.

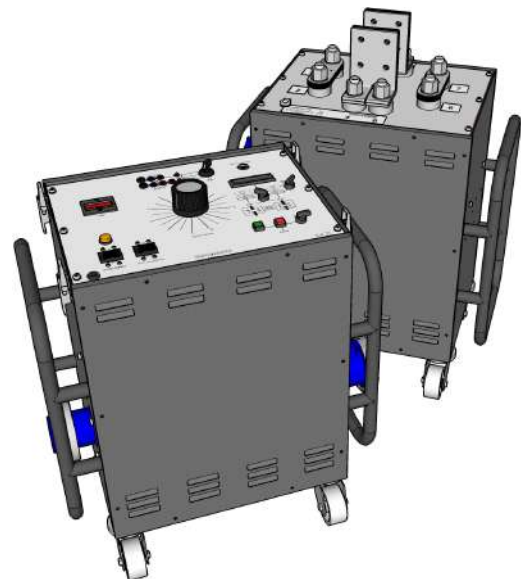

## PCU2 mk5 System Specification

### Metering

The AC output current is metered by a true RMS 4 digit memory ammeter with an LED display.

		Parallel mode	Series mode
Range 1	Full scale	5000A	2500A
	Resolution	1A	1A
	Accuracy	0.6% rdg+6d	0.6% rdg+6d
	Current trip	5500A	2750A
Range 2	Full scale	10.00kA	5.00kA
	Resolution	0.01kA	0.01kA
	Accuracy	0.6% rdg+6d	0.6% rdg+6d
	Current trip	11000A	5500A

Memory ammeter acquisition time 200ms

### Loading Unit Output

The output of the loading unit is continuously variable from zero. Each unit may be operated in series/parallel mode to allow for a greater range of load impedances. All metering and tripping functions are handled by the control unit.

		LU5000		LU6000	
		Parallel mode	Series mode	Parallel mode	Series mode
	Open circuit V	0-4V	0-8V	0-3.3V	0-6.6V
Continuous	Current	2500A	1250A	3000A	1500A
	Max kVA	10	10	10	10
5 min on/ 15 min off	Current	5000A	2500A	6000A	3000A
	Max kVA	20	20	20	20
5 sec on	Current	8000A	4000A	9600A	4800A
	Max kVA	32	32	32	32
1 sec on	Current	10000A	5000A	12000A	6000A
	Max kVA	40	40	40	40

### Protection and Safety

The PCU2 mk5 and loading units are CE marked and are designed to meet the requirements of BS EN61010.

The system is protected by a circuit breaker and fuse on the mains input, a circuit breaker on the loading unit output and an electronic trip on the output.

### Supply Requirements

230V±10% 49-61Hz 1ph 23kVA 5 min/46kVA 1s

### Temperature Range

Storage -20 °C to 60 °C, Operating 0 °C to 45 °C

### Timing System

The PCU2 mk5 has a flexible timing system with two contact inputs and 5 operating modes. Both the start and stop contact circuits will accept volt free contacts. Each contact circuit automatically selects for N/O or N/C contacts, and the status of each contact input is shown by an LED. In addition to contact operation, the first timing channel may be triggered by a DC voltage between 24 and 240V. The timing system will also respond to the rise and fall of current in the test object for devices where no auxiliary contact is available. A pulse mode is also provided to allow injection for short periods (500ms) to avoid unnecessarily heating thermal trips.

Timer resolution	1ms
Timer full scale	999.999s
Timer accuracy	±0.01%rdg+2d ±0.01%rdg+3d current operated mode
Contact O/C voltage	24V
Contact S/C current	100mA
Vdc input range	24-240Vdc

Timer mode	Timer start	Timer stop
Normal	'On' button	Contact
Single contact	Contact 1	Contact 1
Dual contact	Contact 1	Contact 2
Current	Current >20% of range	Current <20% of range
Off	Timer inactive	

### Accessories supplied with system

Spare fuse set, operating manual.  
1 x 5m loading unit power interconnection lead.  
1 x 5m loading unit metering interconnection lead.  
1 x 2m mains lead

Unit	Dimensions	Weight
Control unit	660 x 400 x 740mm	115kg
LU5000	660 x 400 x 740mm	155kg
LU6000	660 x 400 x 740mm	135kg

### Optional Output Lead Set Specifications

A range of output lead sets are available to complement the PCU2 mk5 system with current ratings between 3000A and 6000A. The leads are double insulated and have good flexibility.

Type	Length	CSA	Termination
3000AL	2.5m	560mm <sup>2</sup>	Copper bar
4000AL	2.5m	700mm <sup>2</sup>	Copper bar
5000AL	2m	840mm <sup>2</sup>	Copper bar
6000AL	2m	1120mm <sup>2</sup>	Copper bar

Other output lead lengths are available on request.

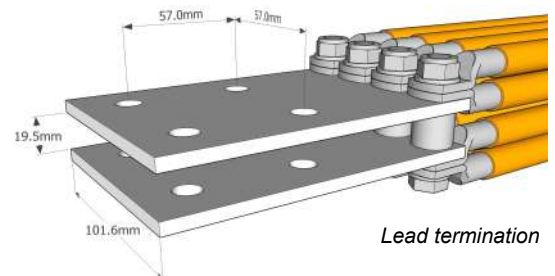

# PCU1-C

# Cable Impedance



## Features

- Measure impedance of overhead lines and underground cables
- Direct readout of cable Z & X
- Phase angle display
- Voltage up to 300V and current up to 80A
- Data storage to CSV file on USB memory key
- Multi-function digital timing system
- Digital true RMS memory ammeter & voltmeter
- Solid state switching
- Rugged, compact design

The PCU1-C is a cable impedance test system for the measurement of impedance of overhead lines and underground cables. The system consists of a separate control unit containing all metering and control functions and an output transformer that provides isolation of the output current and feedback voltage.

A current is injected into the line under test and the resultant magnitude and phase angle of the voltage across the line is measured. The current, voltage, phase angle and impedance of the line (Z & X) under test are displayed. In addition, the harmonic content of the voltage and current can be displayed.

The unit has data logging facilities using a standard USB memory key. Date, time, current, voltage, phase angle, and frequency are

stored to a CSV file on the memory key along with a comment entered using the supplied USB keyboard. Pressing the “store” pushbutton causes a new set of values to be written to the CSV file.

The output has three taps (75V, 150V & 300V), allowing the measurement of impedance of a wide range of lines and cables. All metering is true rms. Four current ranges (2.000, 10.00, 20.00 and 100.0A) and two voltage ranges (30.00V and 300.0V) are provided.

The output transformer unit uses 6mm safety connectors for all outputs and 4mm safety connectors for inputs. A block of

connectors is provided adjacent to the output to allow easy parallel connection of cables for parallel measurements on all three phases.

The unit is provided with a set of four 10m 12mm<sup>2</sup> duplex measurement cables. These provide a 12mm<sup>2</sup> conductor for current injection and a 6mm<sup>2</sup> conductor for voltage feedback in each cable.

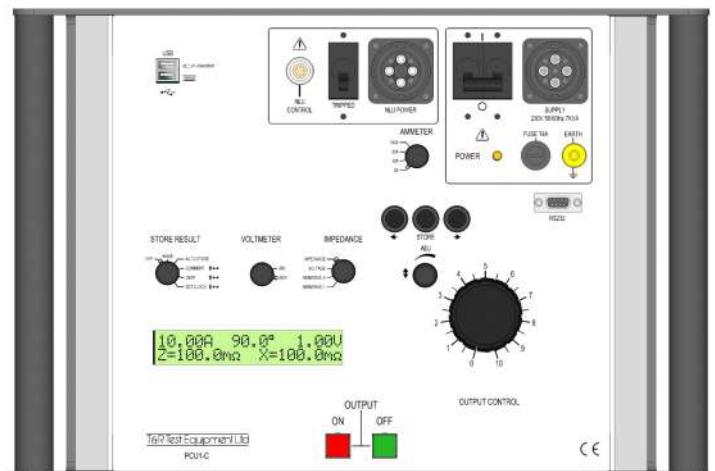

## PCU1-C Specification

The AC output current and load voltage are measured by a true RMS metering system with hold facility. All readings are held when the output is switched off. Four current ranges and two voltage metering ranges are provided.

Range	Full scale	Resolution	Accuracy
2A	2.000A	0.001A	±1%rdg+5d
10A	10.00A	0.01A	±1%rdg+5d
20A	20.00A	0.01A	±1%rdg+5d
100A	100.0A	0.1A	±1%rdg+5d
30V	30.00V	0.01V	±1%rdg+5d
300V	300.0V	0.1V	±1%rdg+5d
Phase	0±180.0°	0.1°	±1°

## Output ratings

Output	Continuous	Current rating	
		5 min on	Maximum
75V 80A	40A	80A	80A
150V 40A	20A	40A	40A
300V 20A	10A	20A	20A

## Data Storage

All test results from the PCU1-C can be stored on a USB memory key. The unit has a real-time clock to time and date-stamp all results. To log results first enter a comment for the results using the USB keyboard, and then select 'auto store'. Whenever the 'store' key is pressed the current, voltage and all other parameters are added to a spreadsheet file on the memory key. The current set of results can be viewed on the display. All results are stored in a folder on the USB key named with the test date in a file named with the time. In addition, the PCU1-C can store the voltage and current waveforms to the USB key in CSV format.

### Sample data stored to USB key

```
"PCU1-C", "v0.12", "C00", "P1", "A1"
"Time", "Date", "Amps", "Volts", "Phase", "Freq Hz", "Z", "X", "Comment"
"11:18:40", "21/12/09", "10.00", "1.000", "90.0", "0.1000", "0.1000", "Cable Sub xx to yy phase A-B"
"11:19:42", "21/12/09", "10.00", "1.000", "90.0", "0.1000", "0.1000", "Cable Sub xx to yy phase B-C"
"11:20:49", "21/12/09", "10.00", "1.000", "90.0", "0.1000", "0.1000", "Cable Sub xx to yy phase C-A"
"11:20:49", "21/12/09", "10.00", "1.000", "90.0", "0.1000", "0.1000", "Cable Sub xx to yy ABC-E"
```

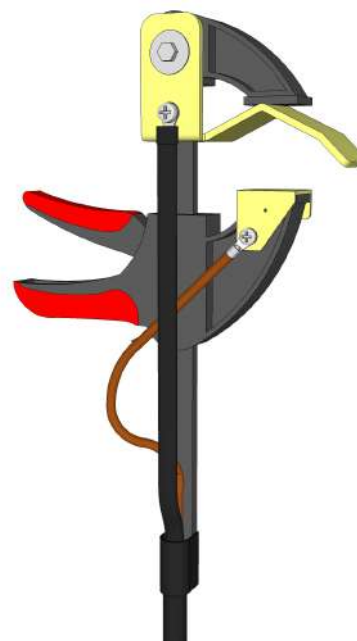
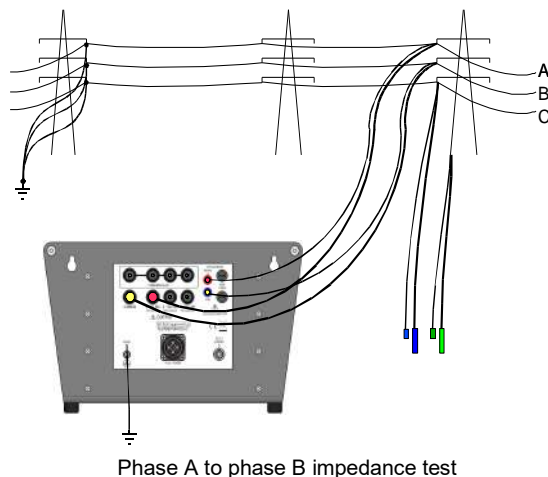

Overhead line Kelvin connection clamp

## Dimensions

PCU1-C	450 x 275 x 305mm
NLU75/80	450 x 275 x 330mm

## Weight

PCU1-C	26kg
NLU75/80	50kg

## Temperature Range

Storage -20°C to 60°C, Operating 0°C to 45°C

## Protection and Safety

Isolation is provided on all outputs and inputs to be connected to the line under test.

The PCU1-C system is CE marked and is designed to meet the requirements of BS EN61010. The system is protected by electronic trips on the outputs, circuit breakers on the mains input and output. The unit also has a duty cycle trip on the loading unit output and comprehensive thermal protection.

## Supply Requirements

230V±10%, 45-65Hz 1ph 7kVA max

## Standard Accessories

Mains lead (5m).

Power and metering interconnection leads (5m).

Earth lead.

3 x 10m overhead line Kelvin connection leads.

1 x 10m earth Kelvin connection lead.

Link lead to connect output to parallel connection block.

USB keyboard, USB memory key.

Operating manual.

Spare fuses.



# DMO200

# Digital Micro-Ohmmeter

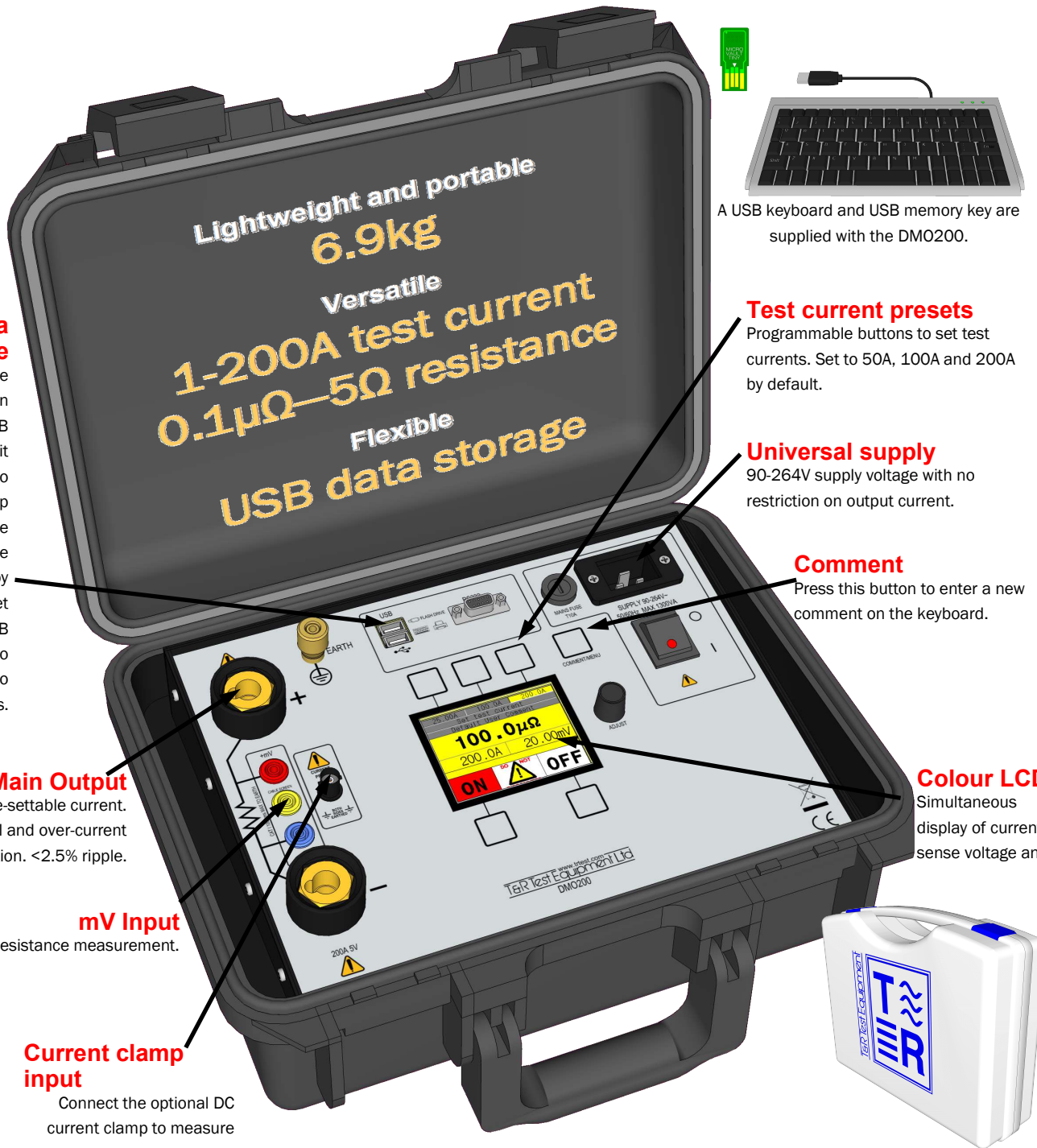

A USB keyboard and USB memory key are supplied with the DMO200.

**USB data storage**  
All test results can be stored automatically on a standard USB memory key. The unit has a real-time clock to time and date-stamp all results. Results are written to a CSV file that can be opened by any spreadsheet program. A USB keyboard is supplied to add comments to results.

**Test current presets**  
Programmable buttons to set test currents. Set to 50A, 100A and 200A by default.

**Universal supply**  
90-264V supply voltage with no restriction on output current.

**Comment**  
Press this button to enter a new comment on the keyboard.

**Main Output**  
5V 1-200A pre-settable current. Thermal and over-current protection. <2.5% ripple.

**Colour LCD**  
Simultaneous display of current, sense voltage and

**mV Input**  
Sense input for 4 wire resistance measurement.

**Current clamp input**  
Connect the optional DC current clamp to measure



**Optional Kelvin clamp lead set**  
Optional 200A Kelvin lead set-current injected and sense voltage measured using one clamp.

**Optional extension lead sets**  
Optional output and sense extension lead sets available in 3m, 5m and 10m lengths.

**Standard lead set**  
High quality 3m 200A output leads in carry case supplied with unit.

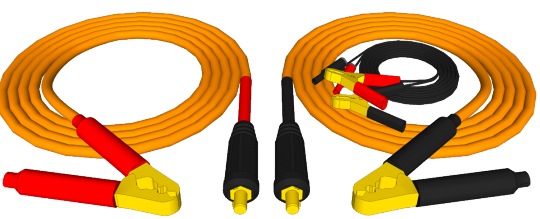
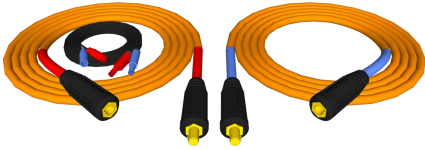
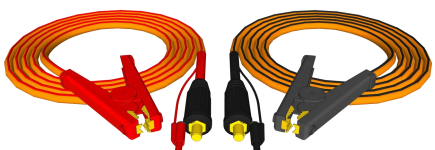

## Example Applications

### Busbar joint resistance

The DMO200 is ideal for measuring busbar joint resistance. Before making connections ensure that the supply is off and necessary earths have been applied. Connect the high current leads to the busbar, ensuring that the joint resistance to be measured is in the circuit. Connect the sense leads as close as possible to the joint to be measured. Select the desired test current using one of the preset test currents (or use the adjust knob to set a custom test current). Switch the output on, and the current rises to the preset current. Switch the output off again, and the reading is held on the display.

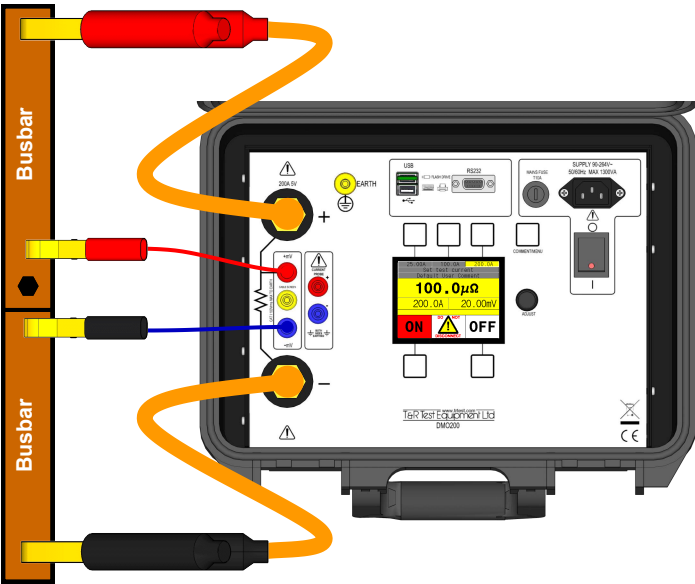

### Storing results

The DMO200 is supplied with a USB memory key and USB keyboard for storing annotated results. To enter or edit a comment tap the COMMENT/MENU button. The comment can then be edited using the keyboard. This comment is stored with each result until a new comment is entered. Each time the output of the unit is switched off the readings from the unit are saved to the USB memory key in CSV format along with the date, time and your comment.

The CSV file can be opened with any spreadsheet program such as Microsoft Excel™ or similar.

1	A	B	C	D	E	F	G	H	I	J
2	DMO200	V1.00	C01							
3	Time	Date	Current	V	ohm	Re,Comment				
4	10:00:00	10/05/2010	200	2.00E-04	1.00E-06	Y South switchyard breaker 3 phase A				
5	10:01:10	10/05/2010	200	2.04E-04	1.02E-06	Y South switchyard breaker 3 phase B				
6	10:02:13	10/05/2010	200	2.02E-04	1.01E-06	Y South switchyard breaker 3 phase C				
7	10:00:00	10/05/2010	200	2.00E-04	1.00E-06	Y South switchyard breaker 4 phase A				
8	10:01:10	10/05/2010	200	2.04E-04	1.02E-06	Y South switchyard breaker 4 phase B				
9	10:02:13	10/05/2010	200	2.02E-04	1.01E-06	Y South switchyard breaker 4 phase C				

### Circuit breaker contact resistance

The DMO200 is suited to all low resistance measurements on power systems, and is particularly suited to measuring contact resistances on substation circuit breakers, isolators and grounding equipment. The unit has a powerful output capable of driving 200A through 20m output leads to reach the contacts of even the largest circuit breakers. Optional output lead extensions are available which extend the high current and sense leads by 3, 5 or 10m.

Accurate measurements on circuit breakers, isolators and grounding links with both sides earthed are simple with the optional current clamp. This allows the current flowing through the earthing equipment to be subtracted from the test current.

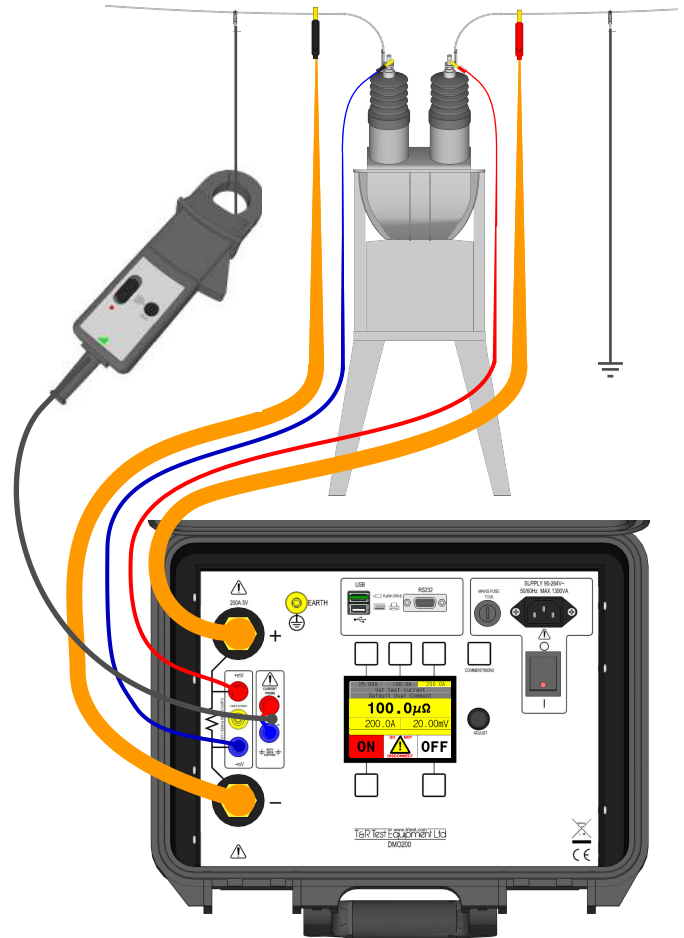

### Specification

Supply requirements: 90-265VaAC 1300VA max

Output: 1-200ADC 5V

Resistance measurement: 0.1μΩ-5Ω

DMO200 dimensions: 360 x 290 x 165mm

DMO200 weight: 6.9kg

Accessories supplied with unit: Mains lead, user manual, 3m high current leads, 3m sense leads, spare fuses.

### Optional accessories

DMO200 current clamp Part no. A224-0001

3m Kelvin clamp lead set in plastic case Part no. A224-0003

Output/sense extension 3m in plastic case Part no. A224-0004

Output/sense extension 5m in plastic case Part no. A224-0005

Output/sense extension 10m in plastic case Part no. A224-0006

# DMO600 *Digital Micro-Ohmmeter with USB data storage*



## Features

- Clear and simple user interface
- 10-600A DC Test Current
- 0.1 $\mu\Omega$ —5 $\Omega$  Resistance
- USB Test Data storage
- 600A for 2 minutes with 15 minutes off
- 200A continuous current
- Colour LCD display
- Programmable test current
- 90-264V supply voltage
- Thermal and over-current protection
- Portable is sturdy case
- Output ripple is <2.5%
- High quality 3m lead set supplied as standard.

T&R Test Equipment is a market leader in the field of power test equipment.

The DMO600 is a 600A micro-ohm meter. It is simple to operate, and automatically maintains desired output current. Output current, voltage and resistance are all displayed simultaneously. The DMO600 uses a four wire Kelvin connection to measure low resistance. The resistance is calculated from the test current and sense voltage.

The unit can output any current from 10A to 600A, and has the option of three pre-programmable test currents, which can be selected at any time. The unit is designed to comply with BSEN61010, and is CE marked.

Three Pre-programmable test currents.

Option to enter a comment using USB keyboard.

Simultaneous display of current, mV and resistance.

Clear output status for user safety

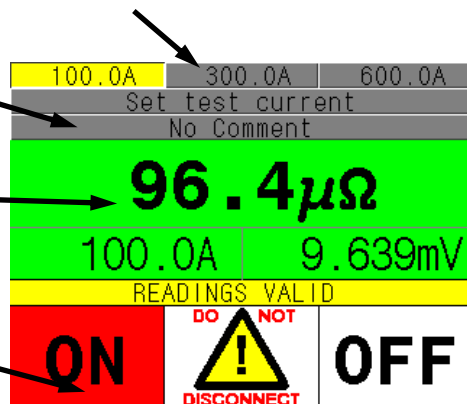

## Storing results

The DMO600 is supplied with a USB memory key and USB keyboard for storing annotated results. To enter or edit a comment tap the COMMENT/MENU button. The comment can then be edited using the keyboard. This comment is stored with each result until a new comment is entered. Each time the output of the unit is switched off the readings from the unit are saved to the USB memory key in CSV format along with the date, time and your comment.

The CSV file can be opened with any spreadsheet program such as Microsoft Excel™ or similar application.

## Test Limits

1	A	B	C	D	E	F	G	H	I	J
2	DMO200	V1.00	C01							
3	Time	Date	Current	V	ohm	Re,Comment				
4	10:00:00	10/05/2010	200	2.00E-04	1.00E-06	Y South switchyard breaker 3 phase A				
5	10:01:10	10/05/2010	200	2.04E-04	1.02E-06	Y South switchyard breaker 3 phase B				
6	10:02:13	10/05/2010	200	2.02E-04	1.01E-06	Y South switchyard breaker 3 phase C				
7	10:00:00	10/05/2010	200	2.00E-04	1.00E-06	Y South switchyard breaker 4 phase A				
8	10:01:10	10/05/2010	200	2.04E-04	1.02E-06	Y South switchyard breaker 4 phase B				
9	10:02:13	10/05/2010	200	2.02E-04	1.01E-06	Y South switchyard breaker 4 phase C				

The DMO600 comes with the option of applying upper and lower pass limits for resistance and length of test for production line applications.

There is the option for up to three limit test setups each with their own resistance limits, and test current times. When the current has been set and the pre-set time has elapsed a pass or fail indication is shown.

## DMO600 Specification

### Main Output

The main output allows for output currents up to 600A.

Range	Continuous	2 minutes
5Vdc	200A	600A

The above intermittent on times must be followed by an off time of 15 minutes, and are based on an ambient temperature of 25°C.

### Metering

The output is metered by a digital true RMS system. Whenever the output is turned off, the current reading is held on the display.

Range	Resolution	Accuracy
10.0-600.0A	0.1A	$\pm 0.5\%rdg \pm 1d$

A current trip is automatically detected.

### Sense Voltage Inputs

Maximum measurement voltage is 5V DC

Range	Resolution	Accuracy
0-9.999mV	0.001mV	$\pm 0.5\%rdg \pm 5d$
10.00-99.99mV	0.01mV	$\pm 0.5\%rdg \pm 5d$
100.0-999.9mV	0.1mV	$\pm 0.5\%rdg \pm 5d$
1.000-5.000V	0.001V	$\pm 0.5\%rdg \pm 5d$

### Resistance accuracy

The calculated resistance accuracy is:

Range	Resistance	Accuracy
100-600A	Full Scale	$\pm 1\%rdg \pm 2d$
10-99A	Full Scale	$\pm 1.5\%rdg \pm 10d$

### Lead Set Specifications

The DMO600 is supplied with a lead set including:

2 x 3m 95mm<sup>2</sup> output leads terminated in large current clamps.  
1 x 3m voltage sense leads, 1 x 5m Earth lead, 1 x 5m Mains lead.

### Supply Requirements

The unit is available for operation from:

90-264Vac -10%+14% 50/60Hz 1ph 3800VA

### RS232

An RS232 port is provided to allow connection of a printer or PC. A PC connection allows for remote control of the output current, and recording of test results.

### Temperature Range

Storage -20°C to 60°C      Operating 0°C to 45°C

### Accessories

Operating manual, output lead set, mains lead, earth lead, USB memory key, USB keyboard.

### Optional Accessories

DMO600 current clamp	Part no. A224-0001
Output/sense extension 3m in plastic case	Part no. A231-0004
Output/sense extension 5m in plastic case	Part no. A231-0005
Output/sense extension 10m in plastic case	Part no. A231-0006

### Dimensions

560 x 456 x 265mm

### Weight

19.7kg

## Example Applications

### Busbar joint resistance

The DMO600 is ideal for measuring busbar joint resistance. Before making connections ensure that the supply is off and necessary earths have been applied. Connect the high current leads to the busbar, ensuring that the joint resistance to be measured is in the circuit. Connect the sense leads as close as possible to the joint to be measured. Select the desired test current using one of the preset test currents (or use the adjust knob to set a custom test current). Switch the output ON, and the current rises to the preset current. Switch the output OFF again, and the reading is held on the display.

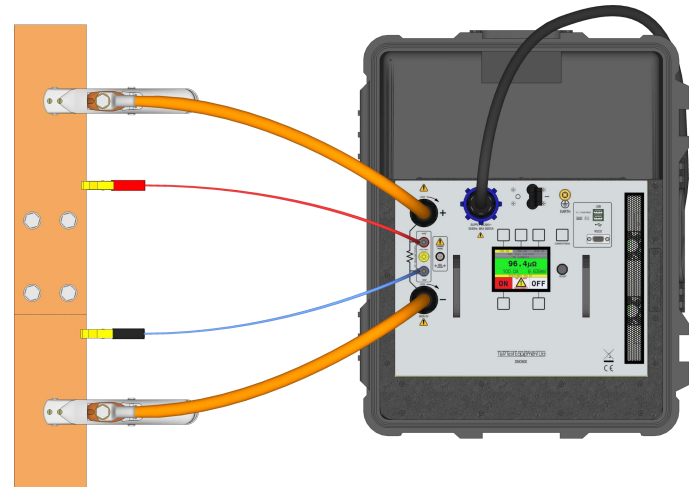

### Circuit breaker contact resistance

The DMO600 is suited to all low resistance measurements on power systems, and is particularly suited to measuring contact resistances on substation circuit breakers, isolators and grounding equipment. The unit has a powerful output capable of driving 600A through 20m output leads to reach the contacts of even the largest circuit breakers. Optional output lead extensions are available which extend the high current and sense leads by 3, 5 or 10m.

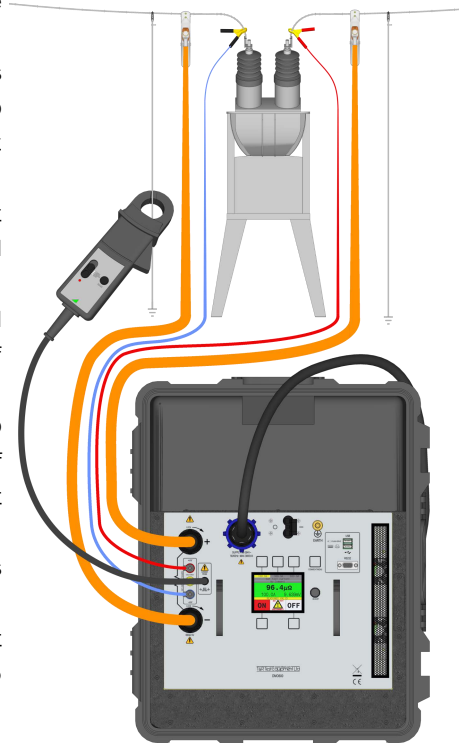

Accurate

measurements on circuit breakers, isolators and grounding links with both sides earthed are simple with the optional current clamp. This allows the current flowing through the earthing equipment to be subtracted from the test current.

**PT18-10<sup>mk2</sup>**  
**PT30-10<sup>mk2</sup>**

# High Voltage DC Cable Test Systems

## Features

- $\pm 18\text{kVdc}$  output voltage (PT18-10)  
 $\pm 30\text{kVdc}$  output voltage (PT30-10)
- 10mA output capability
- Both voltage and current metered on HV outputs
- Automatic earth system for dumping capacitive loads
- HV output plug & socket system
- Key operated supply switch to prevent unauthorised operation
- Automatic mains voltage selection
- Visual indication of test piece failure
- Zero Volt interlock



PT30-10

T&R Test Equipment is a market leader in the field of protection test equipment. The range includes primary and secondary current injection equipment up to 6000A, voltage sources, micro-ohmmeters and high voltage test systems up to 100kV.

The PT18-10 and PT30-10 high voltage DC test sets are designed to perform tests on installed cable and jointing systems. The units have a variable output voltage with a maximum of  $\pm 18\text{kVdc}$  (PT18-10) or  $\pm 30\text{kVdc}$  (PT30-10). Both units have a maximum charging capability of 10mA. A zero-volt interlock is fitted that prevents the output being switched on unless the output control is at zero.

The units include an automatic load discharge system that discharges the cable under test when the output is switched off or a breakdown occurs. The internal dumping system can discharge a maximum of 2.5kJ on each output, corresponding to  $10\mu\text{F}$  at 18kV or  $4\mu\text{F}$  at 30kV. In the event of a test object failure, the overload circuit will automatically switch off the output voltage and earth the output via the internal discharge circuit. A manual discharge probe is also supplied as standard with both units, allowing higher load capacitances to be safely discharged.

The mk2 units introduce automatic 115/230V mains voltage selection, allowing easy transition between site voltages.

The output voltage is metered by two large, linear, analogue instruments marked 0-20kV (PT18-10) or 0-30kV (PT30-10). Test object current is metered by two further analogue instruments with 0-10 scale marking. The meters read 0-10mA directly, or 0-1mA

when the  $\div 10$  push button is operated. The HV output from both units use a high quality plug and socket system, allowing for easy cable replacement.

The PT18-10 and PT30-10 are part of a comprehensive range of AC & DC high voltage systems available from T&R Test Equipment. The line-up includes cable test sets from  $\pm 18\text{kV}$  to  $\pm 30\text{kV}$  DC and pressure test systems up to 100kVAC.



PT18-10

## PT18-10 mk2 & PT30-10 mk2 Specification

### Output

All of the PT series cable test systems have high quality high voltage output connectors, and are supplied with detachable, partially screened output cables

Unit type	Voltage	Continuous	5 minutes
PT18-10	0 to ±18kV	5mA	10mA
PT30-10	0 to ±30kV	5mA	10mA

The above intermittent on times must be followed by an off time of 15 minutes, and is based on an ambient temperature of 25 °C.

### Metering

The positive and negative output voltages on the PT series are metered on the HV output by separate analogue instruments.

Unit	Range	Accuracy
PT18-10	0-20kV	±1.5% of full scale
PT30-10	0-30kV	±1.5% of full scale

The output current on both of the outputs is metered by a dual range analogue instrument. The 1mA range is selected by the +10 pushbutton adjacent to the mA meter.

Unit	Range	Accuracy
PT18-10	10mA	±2.5% of full scale
	1mA	±2.5% of full scale
PT30-10	10mA	±2.5% of full scale
	1mA	±2.5% of full scale

### Overload Protection

The PT18-10 and PT30-10 are protected by an overload trip on the output that operates at 12mA.

### Load Discharge System

The PT18-10 and PT30-10 are fitted with an automatic internal load discharge system that grounds the load via a 20kΩ resistor on each output when the output is switched off. The discharge system is rated to dissipate 2.5kJ once every 15 minutes on each output. The PT18-10 can discharge a maximum load capacitance of 10μF per output from 18kV, and the PT30-10 can discharge a maximum load capacitance of 4μF per output from 30kV.



DP20 Discharge probe

Unit	PT18-10	PT30-10
Maximum discharge energy	2.5kJ	2.5kJ
Maximum discharge capacitance from unit max output voltage	10μF	4μF

The PT series units are supplied with a DP20 or DP40 manual discharge probe to allow the discharge of higher capacitance loads.

	PT18-10	PT30-10
Discharge probe supplied	DP20	DP40
Discharge probe max discharge voltage	20kV	40kV
Resistance	30kΩ	60kΩ
Maximum discharge energy	3.6kJ	7.2kJ
Maximum discharge capacitance from DP max rated voltage	15μF	11μF

### Supply Requirements

**PT18-10 mk2** 115V/230V±10% auto-selecting  
50/60Hz 1ph 600VA max

**PT30-10 mk2** 115V/230V±10% auto-selecting  
50/60Hz 1ph 750VA max

### Protection and Safety

The output of the unit is protected by an overload trip, and the input and control supplies are protected by fuses.

The PT18-10 and PT30-10 are designed to meet the requirements of BS EN61010.

An earth terminal is provided on the units which must be connected to a low impedance local earth (lead not supplied as standard).

### Temperature Range

Storage -20 °C to 60 °C      Operating 0 °C to 45 °C

### Dimensions

**PT18-10** 471 x 144 x 362mm

### Weight

17kg unit only

25kg including bag & leads

**PT30-10** 471 x 191x 362mm

25kg unit only

32kg including bag & leads

### Standard Accessories

Both units: Supply lead, spare fuse, operating manual, 5m HV output leads, 5m output earth lead.

**PT18-10** DP20 discharge probe, carry case, lead bag.

**PT30-10** DP40 discharge probe, carry case including space for leads

### Optional Accessories

	PT18-10 part no.	PT30-10 part no.
10m HV leads	A063-193	A064-111
10m earth lead	A064-112	A064-112
15m HV leads	A063-172	A064-100
15m earth lead	A064-101	A064-101
20m HV leads	A064-156	A064-156
20m earth lead	A064-157	A064-157

# KV5-100 mk2

# High Voltage AC



## Features

- Continuously variable output voltage 0-5kVAC
- Variable trip circuit 2-12mA and 20-120mA
- Output voltage and current metering
- Visual and audible indication of test piece failure
- Compact lightweight instrument
- Burn feature giving 100mA maximum current on short circuit
- Key operated switch preventing unauthorised operation
- Complies with the testing requirements of BS1363

T&R Test Equipment is a market leader in the field of protection test equipment. The range includes primary and secondary current injection equipment up to 6000A, voltage sources, micro-ohmmeters and high voltage test systems up to 100kV.

The KV5-100 mk2 high voltage test set is a general purpose test instrument designed for testing insulation systems and the measurement of breakdown voltage on electrical plant and components.

The unit has an output voltage adjustable from zero to 5kV with accurate metering on both the output voltage and current. A zero-voltage interlock is provided, ensuring that the output may only be energised with the voltage control at zero.

The output voltage is metered by a large, linear analogue instrument with a dual-scale marking of 0-3kV and 0-6kV. Load current is metered by a second analogue instrument with 0-10 scale marking. Two current ranges are selectable: 0-10mA and 0-100mA.

The test object and output are protected by an adjustable current trip linked to the current metering range. The trip level may be set to 20-120% of the current metering range on 20% steps.

Breakdown of the test object is both audibly and visibly indicated. The alarm must be manually reset after a trip condition before testing can be resumed.

The instrument is supplied in a compact and portable case with permanently connected test leads. The test leads are terminated in

clips. The unit is designed for operation in conjunction with a suitable interlocked test enclosure or high voltage test area.

The KV5-100 mk2 is one of a range of high voltage test systems available from T&R Test Equipment.

Unit type	Voltage	Current
KV5-100 mk2	5kV	100mA
KV15-80D	15kV	80mA
KV30-40D mk2	30kV	40mA
KV30-100 mk2	30-kV	100mA
KV50-100 mk2	50kV	100mA
KV50-200 mk2	50kV	200mA
KV100-100 mk2	100kV	100mA



## KV5-100 mk2 Specification

### Output

The main output on the unit is variable between 0 and 5kVAC. The output is rated at 50mA continuously and 100mA for 5 minutes followed by an off time of 15 minutes.

### Metering

The output voltage is metered by an analogue instrument with 0-3kV and 0-6kV scaling.

Range	Accuracy
3kV	±1.5% of FS
6kV	±1.5% of FS

The output current is metered by a dual range analogue instrument with 0-10mA and 0-100mA ranges. The current trip may be set to 20-120% of the selected range in 20% steps.

Range	Trip Current	Accuracy
10mA	2-12mA	±3% of FS
100mA	20-120mA	±3% of FS

### Overload Protection

An electronic overload protection circuit is provided on the KV5-100 mk2, backed up by a fuse. The trip current is user selectable, and allows values between 2mA and 120mA to be set. A trip condition is indicated by an illuminated push button and an audible alarm.

### Burn Circuit

When in circuit, the maximum short circuit current is limited to 100mA. When out of circuit, the maximum short circuit current is approximately 2A.

### Output connections

The KV5-100 mk2 is provided with battery clips for connection to the object under test. The unit is designed to be operated in conjunction with an interlocked test enclosure ensuring safety for the user.

### Interlock Circuits

The unit has a zero volt interlock that prevents the output being energised unless the output control is in the zero position. An external interlock connection is also provided, allowing the fitting of external emergency off buttons and test enclosure/cage door interlocks.

### Supply Requirements

115V±10% 50/60Hz 1ph 600VA max  
240V±10% 50/60Hz 1ph 600VA max

### Protection and Safety

The unit is protected by electronic over current trips on the outputs and a fuse on the mains. An earth terminal is provided for connection to a local earth.

The unit is designed to comply with BSEN61010, and is CE marked. The unit must be installed to the requirements of BS EN50191.

### Temperature Range

Storage -20 °C to 60 °C  
Operating 0 °C to 45 °C

### Dimensions

364 x 147 x 262mm

### Weight

16.5kg

### Accessories

Operating manual, mains lead, spare fuse.

### Variants

The KV5-100T mk2 is available as the KV5-100 mk2 with a timer. Other voltages and ratings for this unit are available as special products on request. Such as the KV4-300, a unit with a 4kV, 300mA rating. Units have also been supplied with a 3kV 250mA rating. If you would like a quote for your specific requirements please contact us.



# KV30-40D mk2 Digital Metering

# High Voltage AC Test System



## Features

- 0-30kV output voltage
- Automatic mains voltage selection
- Key operated supply switch to prevent unauthorised operation
- Dual overload protection
- Variable electronic trip - 10-110% of rated output
- Voltage and current digital metering
- Zero-volt interlock
- External 24VDC interlock circuit
- Test timer
- Emergency stop
- Visual indication of test piece failure

The KV30-40D mk2 high voltage test set is a general purpose test instrument designed for testing insulation systems and the measurement of breakdown voltage on electrical plant and components.

The unit is supplied in a compact, portable case with a permanently connected 2 metre long HV output lead.

The KV30-40D mk2 is one of a family of 1200VA high voltage units spanning the range 6kV 200mA to 30kV 40mA. All supplied with digital metering.

Unit	Maximum Voltage	Maximum current	kV meter resolution	mA meter resolution
KV30-40D mk2	30kV	40mA	0.01kV	0.02mA

The output voltage is variable up to 30kV. A zero-voltage interlock is provided, ensuring that the output may only be energised with the voltage control at zero. The output voltage and current are metered by large true RMS reading digital meters.

Unit	Maximum Voltage	Maximum current
KV6-200D	6kV	200mA
KV10-120D	10kV	120mA
KV15-80D	15kV	80mA
KV30-40D mk2	30kV	40mA

The unit features automatic mains voltage selection and an external 24VDC interlock circuit for connection of emergency-off switches and interlock switches on the test enclosure.

The test object and output are protected by an adjustable electronic current trip. The trip level may be set to 10-110% of the rated output in 10% steps. Breakdown of the test object is visibly indicated and the unit must be manually reset after a trip condition before testing can be resumed.

A test timer is provided for pre-selectable test times of 5 seconds to 5 minutes.

High voltage test systems are also available from T&R Test Equipment up to 100kV 100mA.



KV100-100  
100kV 100mA

## KV30-40D mk2 Specification

### Supply Requirements

115V/230V±10% auto-selecting  
50/60Hz 1ph 1200VA max

### Output

The output of the KV30-40D mk2 is supplied via a permanently connected partially screened high voltage cable. This stows in the lid for transit along with the ES30 earthing stick.

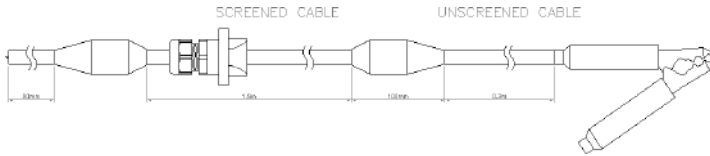

The output of the KV30-40D mk2 is rated at 40mA on a duty cycle of 5 minutes on/15 minutes off or 20mA continuously. These ratings are based on an ambient temperature of 25°C.

### Metering

The output voltage and current are metered by large, accurate true RMS digital meters. The meters are backlit and have a digit height of 19mm.

### Test Timer

A pre-selectable test timer is provided for timed tests of 5, 10, 15, 20, 30 seconds, 1, 2, 3 or 5 minutes. An alarm sounds when the test time has ended.

### Overload Protection

Two overload protection circuits are provided on the units. The first is user selectable, and allows trip currents between 10% and 110% of the rated output to be set. A trip condition is indicated by an illuminated push button and an audible alarm. The second trip circuit is a magnetic circuit breaker operating on the primary of the HV transformer. This operates on large overloads (such as flashovers).

### Protection and Safety

In addition to the output protection the input and control supplies are protected by fuses.

All units are designed to meet the requirements of BS EN61010.

An earth terminal is provided on the transformer which must be connected to a low impedance local earth.

An emergency stop will cut all power to the output, when activated.

### Temperature Range

Storage -20°C to 60°C      Operating 0°C to 45°C

### Dimensions

300 x 400 x 470mm

### Weight

42kg

### Accessories supplied with unit

Supply lead, spare fuse set, operating manual, 5m earth lead, ES30 earthing stick.

### Special Products

If you require a different output voltage test system, please contact us with your specification and we will quote for a custom design.



ES30 Earthing stick

# KV50-20D

## High Voltage AC Test System

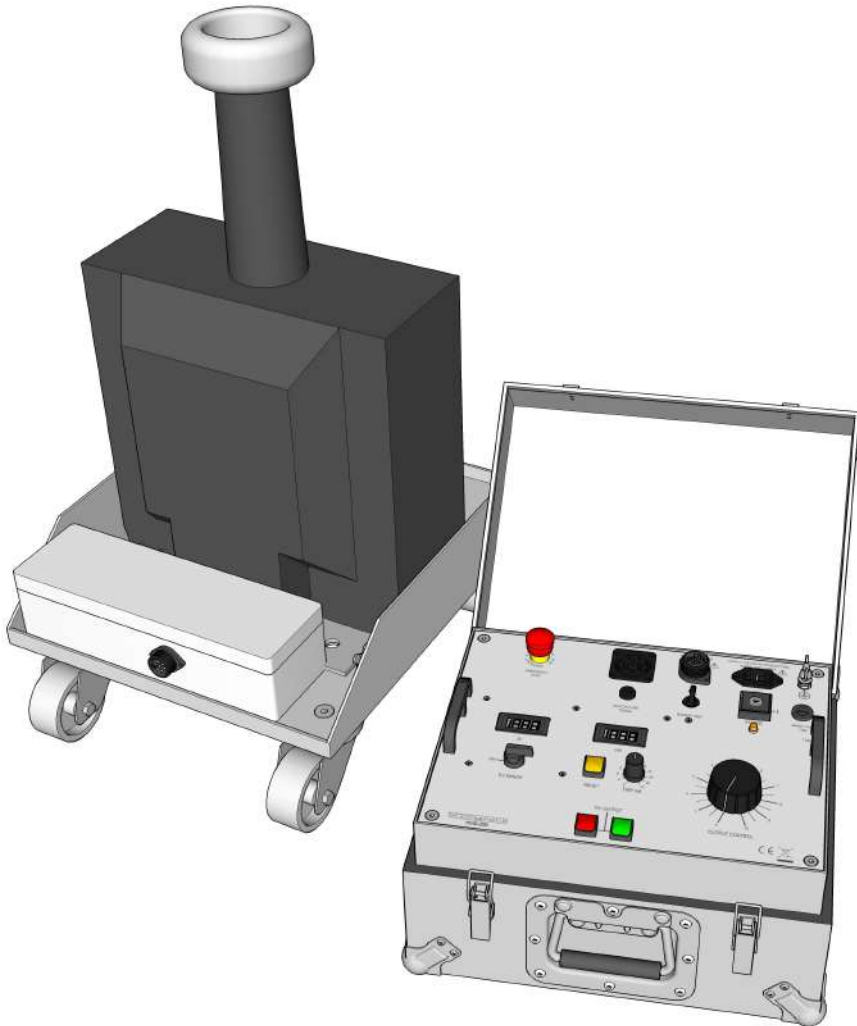

### Features

- 0-50kV output voltage
- 20mA maximum output current
- Auto-selecting 115/230V supply voltage
- Key operated supply switch to prevent unauthorised operation
- Dual overload protection
- Variable electronic trip
- Voltage and current metering
- External interlock circuit
- Zero-volt interlock
- Visual indication of test piece failure
- Cast resin HV transformer

The KV50-20D is a low power portable high voltage AC test system designed for insulation testing. This system is equally suited to both development and routine testing of electrical insulation systems and plant.

The equipment consists of a control unit and a separate resin cast high voltage transformer linked by a 5 metre control cable. The control unit is housed in a rugged aluminium case with a hinged, removable lid for protection. The high voltage transformer is mounted on a base with swivel castors for mobility.

The control unit is fitted with a comprehensive range of facilities for control, metering and protection, including an emergency off switch. The output RMS voltage and current are displayed on digital meters. A variable electronic trip is provided, allowing the trip current to be set to 10-110% of rated output.

The unit is designed to be operated with the HV transformer inside an interlocked test enclosure. A connector is supplied on the control unit to connect interlock switches, extra emergency stop switches and external 24V beacons.

## KV50-20D Specification

### Output

The output of the KV50-20D is via a high voltage bushing. The bushing is designed to be connected to the object under test by an air insulated connection such as copper tubing or tinned copper wire (not supplied with the system). The earthy end of the HV winding is connected to earth via the current metering circuit.

Output voltage 0-50kVAC

Output current 12mA continuous

20mA 5 min on/15min off

### Metering

The output voltage is metered by a true rms digital instrument.

	20kV range	50kV range
Full scale	19.99kV	
Resolution	0.1kV	
Accuracy (no load)	±2% of rdg + 5d	±2% of rdg + 5d
Accuracy (@12mA)	±5% of rdg + 5d	±5% of rdg + 5d

Load current is metered by a true rms digital instrument.

	20mA range
Full scale	19.99mA
Resolution	0.01mA
Accuracy	±2% of rdg + 5d

### Control

The output voltage is set by a continuously variable output control with a zero volt interlock - the output may only be switched on with the control in the zero position. The output voltage is switched on and off by illuminated push button switches.

The mains supply switch for the unit is a key operated switch. The key is trapped in the switch in the 'on' position.

### Supply requirements

115/230V±10% auto-selecting 50/60Hz 1ph 1.5kVA max

### Protection and safety

The output of the units are protected by variable electronic trips monitoring the output current, and a fixed over-current trip on the primary of the output transformer. The variable trip is adjustable in 10% steps between 10% and 110% of the rated output current.

The input and control supplies are protected by fuses.

The KV50-20D is designed to meet the requirements of BS EN61010. The unit must be installed in a high voltage test area complying with the requirements of BS EN50191.

Earth terminals are provided on the control unit and HV transformer that must be connected to a low impedance local earth.

### Interlock circuits

Two interlock circuits are provided on the KV50-20D. A zero voltage interlock is fitted which prevents the HV output being energised unless the output voltage control is in the zero position. An external interlock circuit is also provided, allowing the fitting of external emergency off buttons and test cage door interlocks.

### Beacon output

A beacon output is provided on the control unit to control 24V beacons (max 0.5A). The beacons mimic the state of the HV on and off indicators on the unit—green for HV off and red for HV on.

### Temperature Range

Storage -20 °C to 60 °C      Operating 0 °C to 45 °C

### Dimensions

KV50-20 Control Unit 380 x 314 x 221mm  
KV50-20 Transformer 490 x 520 x 795mm

### Weight

17kg  
75kg

### Accessories

1 x 2m power supply lead.  
1 x 5m interconnecting lead.  
1 x 3m test object earth lead.  
1 x 5m earth lead.  
Spare fuse set.  
Operating manual.

# KV30-100 mk2 KV50-100 mk2

## High Voltage AC Test Systems

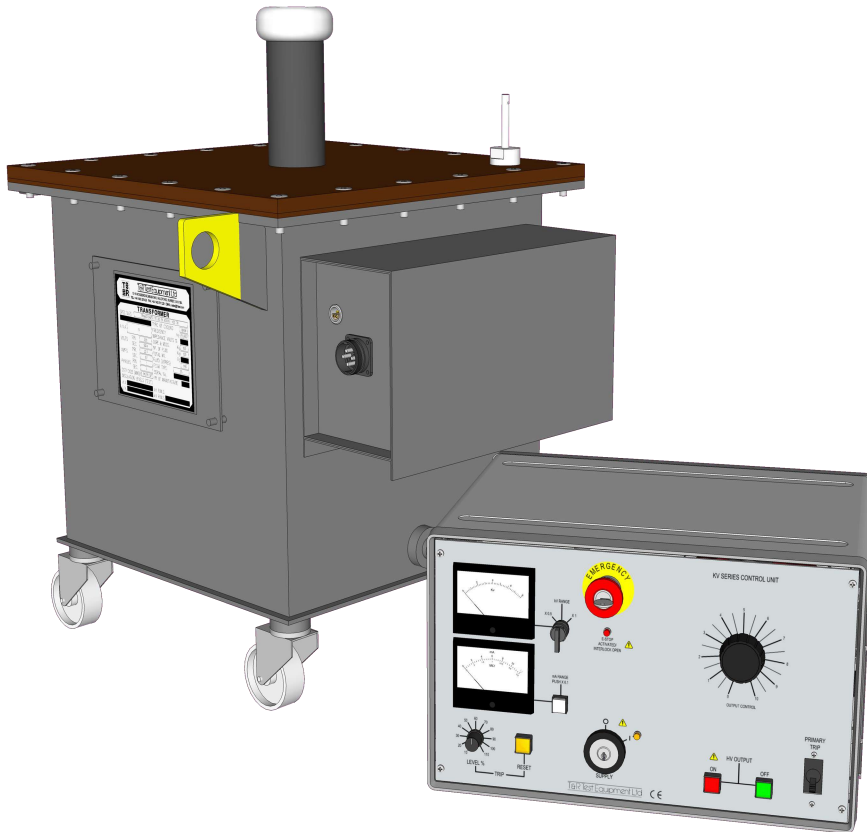

### Features

- 0-30kV (KV30-100 mk2) or 0-50kV (KV50-100 mk2) output voltage
- 3kVA (KV30-100 mk2) or 5kVA (KV50-100 mk2) output capability
- Key operated supply switch to prevent unauthorised operation
- Dual overload protection
- Variable electronic trip - 10-110% of rated output
- Voltage and current metering
- External interlock circuit
- Zero-volt interlock

The high voltage transformer is housed in an oil-filled steel tank fitted with swivel castors for mobility. The units use a high voltage bushing for the HV output, and the other end of the HV winding is earthed. Both the KV30-100 mk2 and KV50-100 mk2 are equally suited to testing capacitive, resistive or inductive test objects.

The KV30-100 mk2 and KV50-100 mk2 are high power, high voltage AC test systems designed for insulation testing. These systems are equally suited to both development and routine testing of electrical insulation systems and plant.

The equipment consists of a control unit and a separate oil filled high voltage transformer, linked by a 5 metre supply and control cables. The control unit is fitted with a comprehensive range of facilities for control, metering and protection. The output voltage and current are displayed on large, linear analogue instruments, and a variable electronic trip is provided, allowing the trip current to be set to 10-110% of rated output.

If higher voltage or output power is required, please refer to our KV50-200 mk2/KV100-100 mk2 data sheet, detailing our 10kVA high voltage systems.

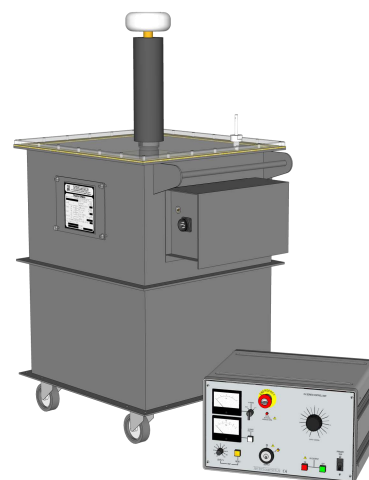

KV100-100 mk2 10kVA system

## KV30-100/KV50-100 mk2 Specification

### Output

The output of the KV series units is by a high voltage bushing. The bushing is designed to be connected to the object under test by an air insulated connection such as copper tubing (not supplied with the system). The earthy end of the HV winding is connected to earth via the current metering circuit.

#### Continuous Ratings

	KV30-100 mk2	KV50-100 mk2
Voltage	0-30kVAC	0-50kVAC
Current	50mA	50mA
Power	1.5kVA	2.5kVA

#### Intermittent Ratings (5 minutes on/15 minutes off)

	KV30-100 mk2	KV50-100 mk2
Voltage	0-30kVAC	0-50kVAC
Current	100mA	100mA
Power	3kVA	5kVA

If you require a different output voltage test system, please contact us with your specification and we will quote for a custom design.

### Metering

The output voltage is metered on the primary of the HV transformer, connected to an average-reading dual scaled analogue instrument.

	x0.5 range	x1 range	Accuracy
KV30-100 mk2	0-20kV	0-40kV	±2% of FS
KV50-100 mk2	0-30kV	0-60kV	±2% of FS

The accuracies shown for voltage metering are for no-load conditions.

Load current is metered in the earthy end of the HV winding by an average-reading analogue instrument.

	mA Meter	Accuracy
KV30-100 mk2	0-120mA	±2% of FS
KV50-100 mk2	0-120mA	±2% of FS

### Control

The output voltage is set by a continuously variable output control with a zero volt interlock - the output may only be switched on with the control in the zero position. The output voltage is switched ON and OFF by illuminated push button switches.

The mains supply switch for the unit is a key operated switch. The key is trapped in the switch in the ON position.

### Supply Requirements

KV30-100 mk2	230V±10%	50/60Hz	1ph	3.5kVA max
KV50-100 mk2	230V±10%	50/60Hz	1ph	6kVA max

### Protection and Safety

The output of the units are protected by variable electronic trips monitoring the output current, and a fixed over-current trip on the primary of the output transformer. The variable trip is adjustable in 10% steps between 10% and 110% of the rated output current.

The input and control supplies are protected by fuses.

The KV30-100 mk2 and KV50-100 mk2 are designed to meet the requirements of BS EN61010. The unit must be installed in a high voltage test area complying with the requirements of BS EN50191.

An earth terminal is provided on the transformer which must be connected to a low impedance local earth.

### Interlock Circuits

Two interlock circuits are provided on the KV series test systems. A zero voltage interlock is fitted which prevents the HV output being energised unless the output voltage control is in the zero position. An external interlock circuit is also provided, allowing the fitting of external emergency off buttons and test cage door interlocks. The KV30-100 mk2 and KV50-100 mk2 external interlocks operate at 230VAC.

### Temperature Range

Storage	-20°C to 60°C	Operating	0°C to 45°C
---------	---------------	-----------	-------------

### Dimensions

		Weight
KV30-100 mk2 Control Unit	370x480x290mm	25kg
KV50-100 mk2 Control Unit	370x480x290mm	25kg
KV30-100 mk2 Transformer	480x460x570mm	210kg
KV50-100 mk2 Transformer	490x520x795mm	230kg

### Accessories

1 x 5m Power interconnecting lead  
2 x 5m Metering interconnection leads  
Spare fuse set, operating manual.

### Optional Accessories

Test duration timer (must be specified at the time of ordering)

# KV50-200 mk2 KV100-100 mk2

## High Voltage AC Test Systems

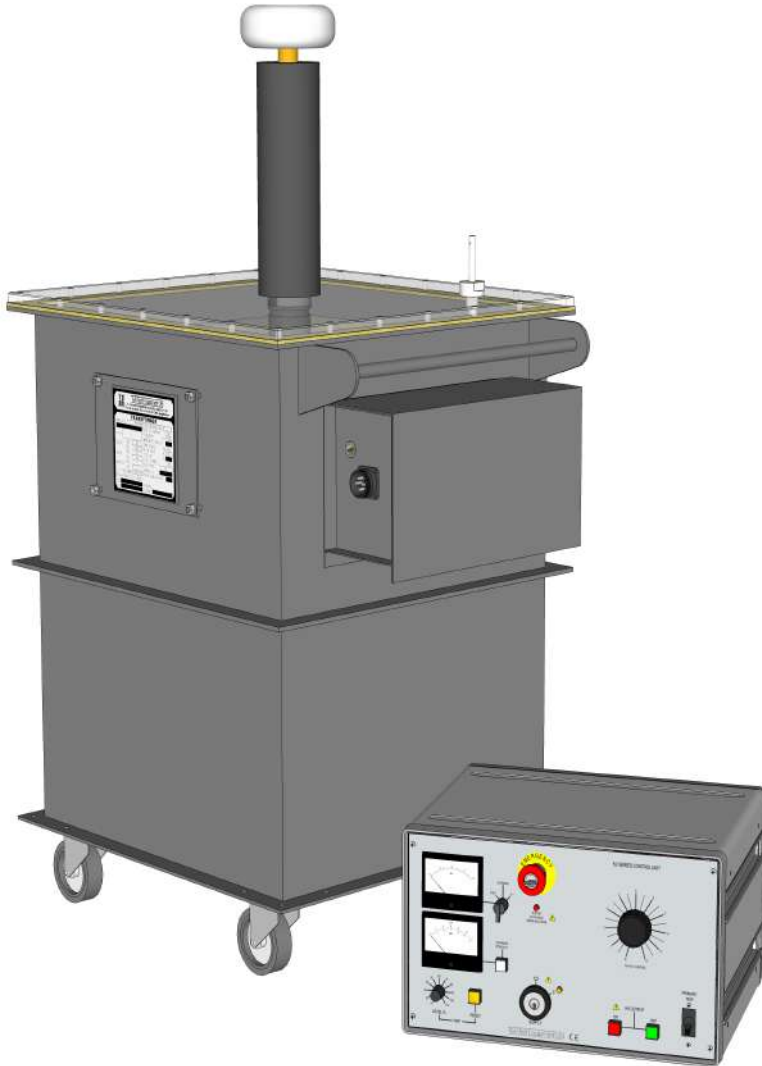

The KV50-200 mk2 and KV100-100 mk2 are high power, high voltage AC test systems designed for insulation testing. These systems are equally suited to both development and routine testing of electrical insulation systems and plant. Each unit is available in either a low partial discharge version or without a specified discharge level.

The equipment consists of a control unit and a separate oil filled high voltage transformer, linked by a 5 metre supply and control cables. The control unit is fitted with a comprehensive range of facilities for control, metering and protection.

### Features

- 0-100kV (KV100-100 mk2) or 0-50kV (KV50-200 mk2) output voltage
- 10kVA output capability
- Key operated supply switch to prevent unauthorised operation
- Dual overload protection
- Variable electronic trip—10-110% of rated output
- Voltage and current metering
- External interlock circuit
- Zero-volt interlock
- Visual indication of test piece failure

Both systems include secondary tap metering as standard to ensure accurate voltage metering. The output voltage and current are displayed on large, linear analogue instruments, and a variable electronic trip is provided, allowing the trip current to be set to 10-110% of rated output.

The high voltage transformer is housed in an oil-filled steel tank fitted with swivel castors for mobility. The units use a low-discharge oil-filled bushing for the HV output. Both the KV50-200 mk2 and KV100-100 mk2 are equally suited to testing capacitive, resistive or inductive test objects. The partial discharge levels on the standard KV50-200 mk2 and KV100-100 mk2 are not specified.

## KV50-200 mk2/KV100-100 mk2 Specification

### Output

The output of the KV series units is by an oil filled high voltage bushing. The bushing is designed to be connected to the object under test by an air insulated connection such as copper tubing (not supplied with the system). The earthy end of the HV winding is connected to earth via the current metering circuit and a removable link. The removable link allows equipment supplied by the user to be connected into the earthy end of the HV winding for Tan-δ measurements.

#### Continuous Ratings

	KV50-200 mk2	KV100-100 mk2
Voltage	0-50kVAC	0-100kVAC
Current	100mA	50mA
Power	5kVA	5kVA

#### Intermittent Ratings (5 minutes on/15 minutes off)

	KV50-200 mk2	KV100-100 mk2
Voltage	0-50kVAC	0-100kVAC
Current	200mA	100mA
Power	10kVA	10kVA

If you require a different output voltage test system, please contact us with your specification and we will quote for a custom design.

### Metering

The output voltage is metered using a tap on the HV winding connected to an average-reading dual scaled analogue instrument.

	x0.5 range	x1 range	Accuracy
KV50-200 mk2	0-30kV	0-60kV	±2% of FS
KV100-100 mk2	0-60kV	0-120kV	±2% of FS

Load current is metered in the earthy end of the HV winding by an average-reading analogue instrument.

	mA Meter	Accuracy
KV50-200 mk2	0-240mA	±2% of FS
KV100-100 mk2	0-120mA	±2% of FS

### Control

The output voltage is set by a continuously variable output control with a zero volt interlock - the output may only be switched ON with the control in the zero position. The output voltage is switched ON and OFF by illuminated push button switches.

The mains supply switch for the unit is a key operated switch. The key is trapped in the switch in the ON position.

### Supply Requirements

230V±10% 50/60Hz 1ph 11kVA max

### Protection and Safety

The output of the units are protected by variable electronic trips monitoring the output current, and a fixed over-current trip on the primary of the output transformer. The variable trip is adjustable in 10% steps between 10% and 110% of the rated output current.

The input and control supplies are protected by fuses.

The KV50-200 mk2 and KV100-100 mk2 are designed to meet the requirements of BS EN61010. The unit must be installed in a high voltage test area complying with the requirements of BS EN50191.

An earth terminal is provided on the transformer which must be connected to a low impedance local earth.

### Interlock Circuits

Two interlock circuits are provided on the KV series test systems. A zero voltage interlock is fitted which prevents the HV output being energised unless the output voltage control is in the zero position. An external interlock circuit is also provided, allowing the fitting of external emergency off buttons and test cage door interlocks.

### Temperature Range

Storage -20 °C to 60 °C      Operating 0 °C to 45 °C

### Dimensions

	Dimensions	Weight
KV50-200 Control Unit	370x480x290mm	37kg
KV100-100 Control Unit	370x480x290mm	37kg
KV50-200 Transformer	570x500x1020mm	220kg
KV100-100 Transformer	730x650x1350mm	390kg

### Accessories

1 x 5m Power interconnecting lead  
 2 x 5m Metering interconnection leads  
 Spare fuse set, operating manual.

### Optional Accessories

Test duration timer (Must be specified at the time of ordering)



# HV TROLLEY2

# High Voltage AC Test System

## Features

- 20kVA output capability
- 0-3kV to 0-15kV options available
- Accurate digital metering
- Key operated supply switch
- Dual overload protection
- Variable electronic trip 10-110% of rated output
- Voltage and current metering
- Optional 5s-5min test timer
- External 24V interlock and zero-volt interlock
- Emergency stop switch



*Also available as a single unit trolley*

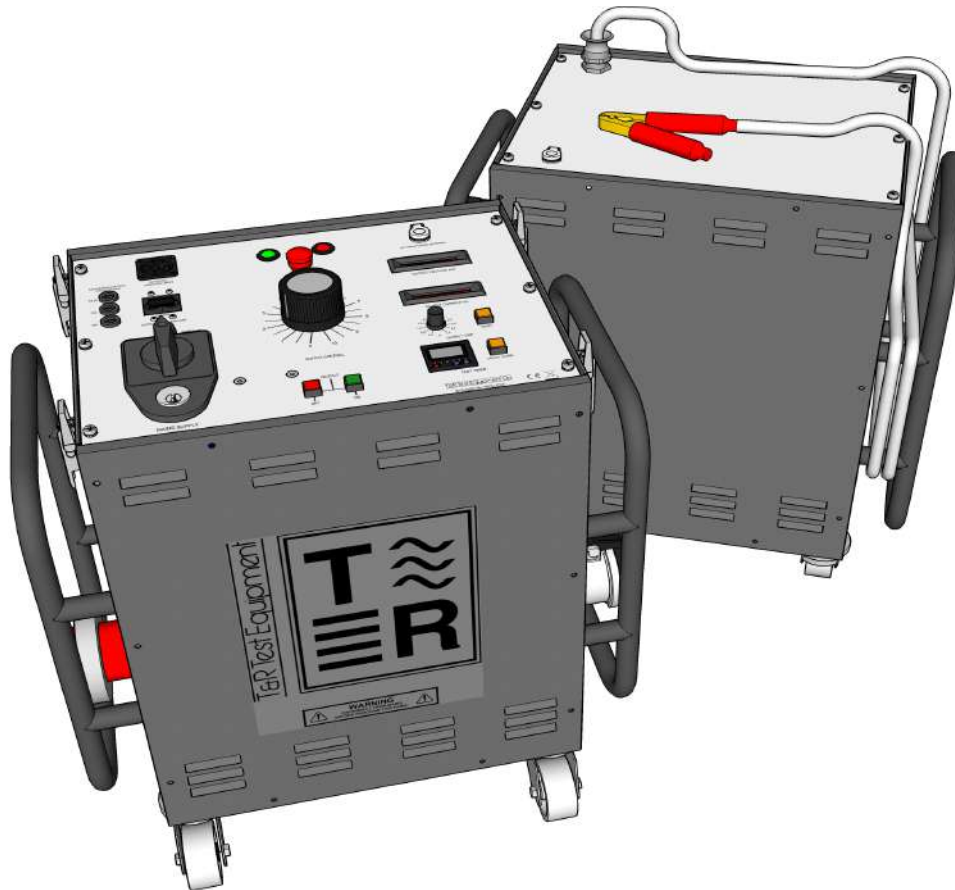

The HV trolley2 series of units are high power AC flash test sets with a 20kVA output capability. The maximum output voltage can be customised to be any voltage up to 15kV. The unit is housed in a rugged aluminium enclosure with a cover to protect the control panel. It is mounted on wheels to allow easy movement within a production environment.

The HV trolley2 is provided with accurate digital voltage and current metering and a variable electronic trip. An external interlock input is also fitted to the unit. Outputs are provided to drive 24V warning beacons.

The HV output is connected to the test object by a high voltage cable 5m long.

## HV Trolley2 Specification

### Output

The output of the HV Trolley2 series units is by a 5m long screened high voltage cable terminated in a large clip. A 5m long silicone covered earth lead is provided to make the earth connection to the test object.

### Ratings

Unit	Output voltage	Continuous rating	5 min on/ 15 minutes off
<b>KV3-7000/2</b>	0-3kV	3.5A	7.0A
<b>KV5-4000/2</b>	0-5kV	2.0A	4.0A
<b>KV8-2500/2</b>	0-8kV	1.25A	2.5A
<b>KV10-2000/2</b>	0-10kV	1.0A	2.0A
<b>KV12-1600/2</b>	0-12kV	0.8A	1.6A
<b>KV15-1200/2</b>	0-15kV	0.6A	1.2A

Other voltages up to 15kV are available—please contact us to discuss your requirements.

### Metering

The output voltage and current are metered using a true rms metering circuit. The output voltage measurement is taken from a divider on the output and will give accurate results regardless of load type.

Unit	kV meter full scale	kV meter resolution	kV meter accuracy
<b>KV3-7000/2</b>	3.000kV	1V	0.8%±6d
<b>KV5-4000/2</b>	5.000kV	1V	0.8%±6d
<b>KV8-2500/2</b>	8.000kV	1V	0.8%±6d
<b>KV10-2000/2</b>	10.00kV	0.01kV	0.8%±6d
<b>KV12-1600/2</b>	12.00kV	0.01kV	0.8%±6d
<b>KV15-1200/2</b>	15.00kV	0.01kV	0.8%±6d

Unit	mA meter full scale	mA meter resolution	mA meter accuracy
<b>KV3-7000/2</b>	7.000A	1mA	0.8%±6d
<b>KV5-4000/2</b>	4.000A	1mA	0.8%±6d
<b>KV8-2500/2</b>	2.500A	1mA	0.8%±6d
<b>KV10-2000/2</b>	2.000A	1mA	0.8%±6d
<b>KV12-1600/2</b>	1.600A	1mA	0.8%±6d
<b>KV15-1200/2</b>	1.200A	1mA	0.8%±6d

### Customisation

Certain aspects of the design can be customised at extra cost including HV & supply lead lengths, output voltage and supply voltage.

### Control

The output voltage is set by a continuously variable output control with a zero volt interlock - the output may only be switched on with the control in the zero position. The output voltage is switched on and off by illuminated push button switches.

The mains supply switch for the unit is a key operated switch. The key is trapped in the switch in the 'on' position.

### Optional Test Timer

The HV trolley2 may optionally be supplied with a test timer (this must be specified at time of ordering, and cannot be retro-fitted). The following times are selectable via a switch: 5, 10, 15, 20 and 30 seconds and 1, 2, 3, and 5 minutes. An alarm sounds at the end of the test time.

### Supply Requirements

Option 1      400V ±10%    50/60Hz      2ph    22kVA max

Option 2      230V ±10%    50/60Hz      1ph    22kVA max

The unit is fitted with a 5m supply lead and 5 or 10m interconnecting leads.

### Protection and Safety

The output of the units are protected by variable electronic trips monitoring the output current and a fixed over-current trip on the primary of the output transformer. The variable trip is adjustable in 10% steps between 10% and 110% of the rated output current. The input and control supplies are protected by fuses.

An emergency stop switch is fitted to the unit.

The HV trolley2 series are designed to meet the requirements of BS EN61010. The unit must be installed in a high voltage test area complying with the requirements of BS EN50191.

An earth terminal is provided on the unit which must be connected to a low impedance local earth.

### Interlock Circuits

Two interlock circuits are provided on the HV trolley2 test systems. A zero voltage interlock is fitted which prevents the HV output being energised unless the output voltage control is in the zero position. An external interlock circuit is also provided, allowing the fitting of external emergency off buttons and test cage door interlocks.

### Temperature Range

Storage -20°C to 60°C      Operating 0°C to 45°C

Unit	Dimensions	Weight
Control unit	660 x 400 x 740mm	115kg
HV transformer	660 x 400 x 740mm	130kg

### Standard Accessories

1 x 5m earth lead terminated in croc clip.

1 x 5m earth lead for connection to local earth (M10 ring crimp).

1 x ES30 earth stick. Spare fuse set, operating manual.

# BT50 series

# 50kV High Voltage AC Test System

The BT50 is a high voltage test system designed for high voltage insulation testing up to 50kV. The system consists of a control unit and an interlocked test enclosure containing all high voltage parts.

The output voltage has three ranges, allowing the output to be adjusted 0-10kV, 0-20kV and 0-50kV. Digital metering of output current and voltage is provided using true RMS measurement. The unit is fitted with zero-voltage interlock, enclosure interlock, emergency stop switches & beacon. The output voltage is metered using a voltage divider.

The enclosure has clearances allowing testing up to 50kV and automatic earthing of the test object. The enclosure has a 100mm port on the rear for extraction of ozone (for connection of a customer-supplied ozone extraction system).

Breakdown of the test object is visually indicated and the unit must be manually reset after a trip condition before testing can be resumed.

## Features

- 50kV maximum output voltage
- 0-10kV/20kV/50kV output ranges  
Selected by keyswitch
- Key operated supply switch
- Pre-settable output voltage 0-50kV
- Maximum output current 32mA for 30 seconds
- Programmable rate of rise of voltage  
0.5kV/s, 1kV/s, 2kV/s
- Overload protection with variable electronic trip
- Digital voltage and current metering
- Interlocked test enclosure
- Emergency stop switches & beacon
- Visual indication of test piece failure

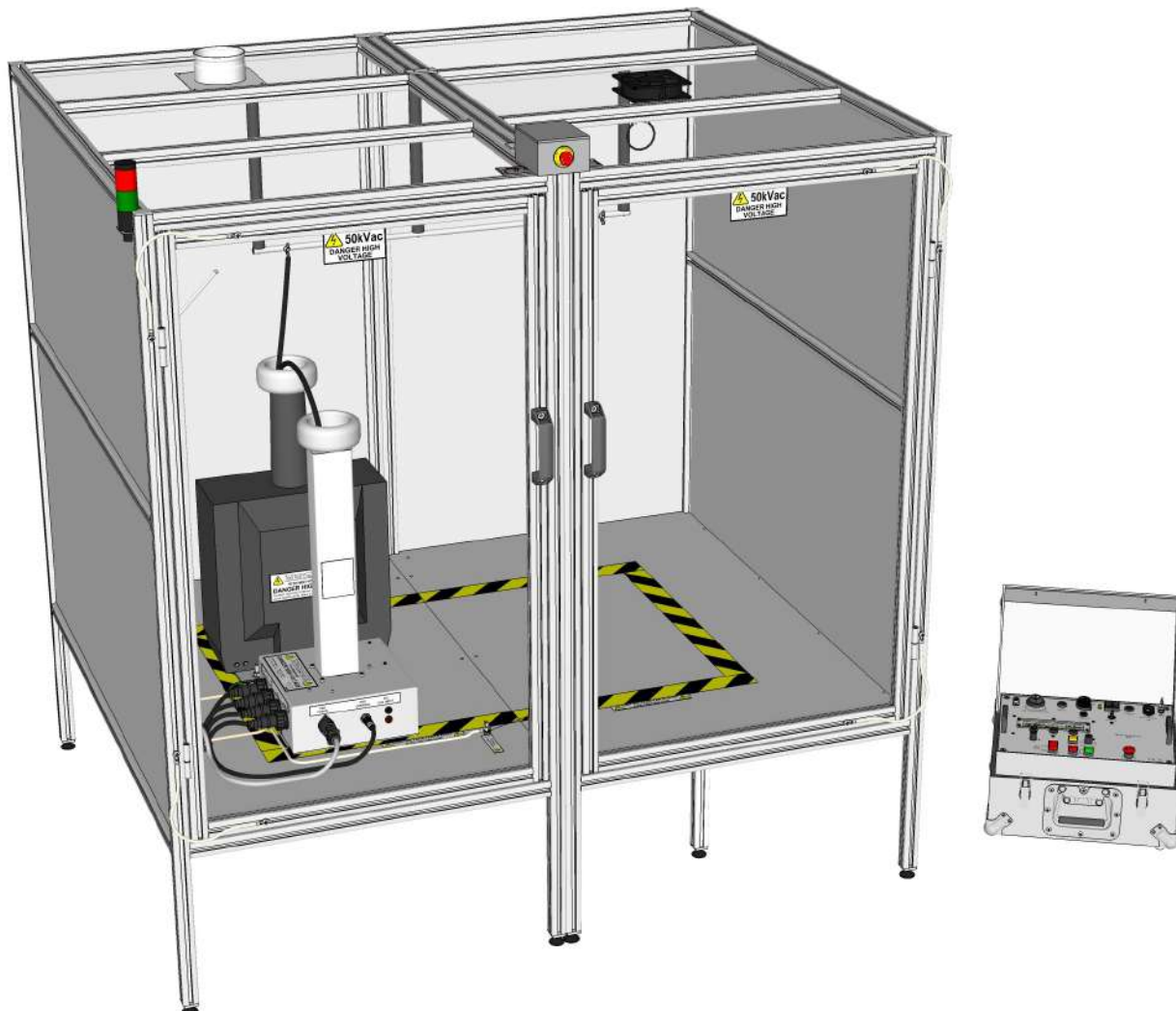

## BT50 Specification

The unit consists of a separate control unit containing all control and metering functions and an interlocked test enclosure containing the high voltage components and test cell.

### Supply Requirements

230V±10% 50/60Hz 1ph 1300VA max

### Output

The output of the BT50 is supplied from the bushing of the HV transformer in the enclosure. A hanging busbar may be used either for high voltage or earth connection to the object under test.

The output of the BT50 is rated at 12mA continuous, 24mA 5 min on/15 min off and 32mA for 30 seconds.

The output has 3 ranges: 0-10kV, 0-20kV and 0-50kV. A key switch selects the output range. The switch may be removed in any position allowing the unit to be locked in any range.

The output voltage is set using a rotary control before the output is switched ON. When the output ON button is pressed, the voltage rises at a pre-set rate to the pre-set final voltage. The output voltage is then held at this value until the output is switched OFF. The output voltage may be manually raised or lowered from the pre-set voltage when the output is ON. All changes are made at the programmed rate of rise. The rate of rise may be set to 500V/s, 1kV/s or 2kV/s.

### Metering

The output voltage and current are metered by true rms reading digital instruments. The voltage reading is held in the case of a failure of the test object.

### Overload Protection

Output range	Full scale	Resolution	Accuracy
0-10kV	10.00kV	0.01kV	±1% rdg±5d
0-20kV	20.00kV	0.01kV	±1% rdg±5d
0-50kV	50.0kV	0.1kV	±1% rdg±5d
mA	32.00mA	0.01mA	±1% rdg±5d

Two overload protection circuits are provided on the units. The first is user selectable, and allows trip currents between 10% and 110% of the rated output to be set. A trip condition is indicated by an illuminated push button and an audible alarm. The second trip circuit is a magnetic circuit breaker operating on the primary of the HV transformer. This operates on large overloads (such as flashovers).

### Enclosure

The system is supplied with an interlocked enclosure suitable for use at up to 50kV. The unit is constructed from aluminium profile with aluminium rear and sides. The top and front are constructed from clear polycarbonate lined with aluminium mesh. A 100mm port is provided on the top of the unit for extraction of ozone.

Reduction of ozone to a specific level is the responsibility of the customer—no guarantee is made as to specific ozone levels within the enclosure.

A fan is provided above the test sample area to circulate fresh air over the test object.

### Calibration

The voltage divider is removable to allow for calibration with the control unit (the HV transformer is not needed for calibration).

### Protection and Safety

The test object is automatically earthed at the end of the test.

In addition to the output protection the input and control supplies are protected by fuses.

The unit is designed to meet the requirements of BS EN61010 and BS EN50191.

An earth terminal is provided on the units which must be connected to a low impedance local earth.

### Temperature Range

Storage -20°C to 60°C      Operating 0°C to 45°C

### Dimensions

Control unit    390 x 310 x 230mm

Enclosure      1500 x 1200 x 1500mm excl. beacon

### Weight

20kg approx

### Parts supplied with unit

Control unit, test enclosure with beacon and automatic earthing, supply lead, interconnecting lead set 2m, earth lead set, spare fuse set and operating manual.

### Variants

Both the control unit and enclosure can be modified for a range of test voltages. The control unit can also be modified for various rates of rise, all can be made customer specific.

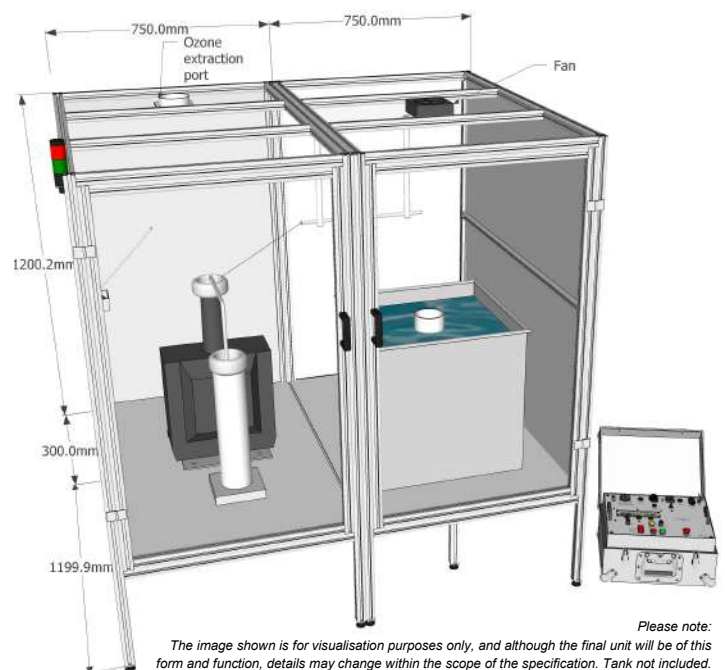

Please note: The image shown is for visualisation purposes only, and although the final unit will be of this form and function, details may change within the scope of the specification. Tank not included.

# DP20 DP40

## High Voltage DC Discharge Probes



### Features

- For discharging high voltage cables after testing
- Earthing hook
- Highly flexible, clear silicone covered earth cable
- For use with the PT18-10 and PT30-10 cable test sets

The DP20 and DP40 discharge probes are designed for discharging high voltage cables after testing. The probes are supplied as standard accessories for the T&R PT18-10 and PT30-10 cable test sets, and are also available separately.

The discharge probes consist of a pointed probe connected to a 5m long earth lead via a series of surge resistors with an insulated handle. The earth lead insulation is clear silicone allowing the conductor to be easily inspected, and is terminated in an M6 hooked crimp.

	DP20	DP40
Maximum discharge voltage	20kV	40kV
Maximum discharge energy	3.6kJ	7.2kJ
Maximum discharge capacitance	12 $\mu$ F	6 $\mu$ F
Resistance	30k $\Omega$	60k $\Omega$
Length	530mm	900mm
Earth lead length	5m	5m
Earth lead CSA	6mm <sup>2</sup>	6mm <sup>2</sup>

# ES30 ES50 ES100 Earth Sticks



### Features

- For earthing high voltage connections
- Highly flexible, clear silicone covered earth cable

The ES30, ES50 and ES100 earthing sticks are designed for earthing the high voltage connection after AC testing in accordance with EN50191. The earthing sticks consist of a hooked earth connection mounted on an insulated handle with a 5m earth lead. The earth lead insulation is clear silicone allowing the conductor to be easily inspected, and is terminated in an M6 hooked crimp.

	ES30	ES50	ES100
Maximum voltage	30kV	50kV	100kV
Length	670mm	840mm	1270mm
Earth lead length	5m	5m	5m
Earth lead CSA	6mm <sup>2</sup>	6mm <sup>2</sup>	6mm <sup>2</sup>

Each of the earth sticks unscrews into two sections for easy storage and transport.

**Note: Under no circumstances must these discharge/earthing probes be used on energised distribution systems.**

# Notes

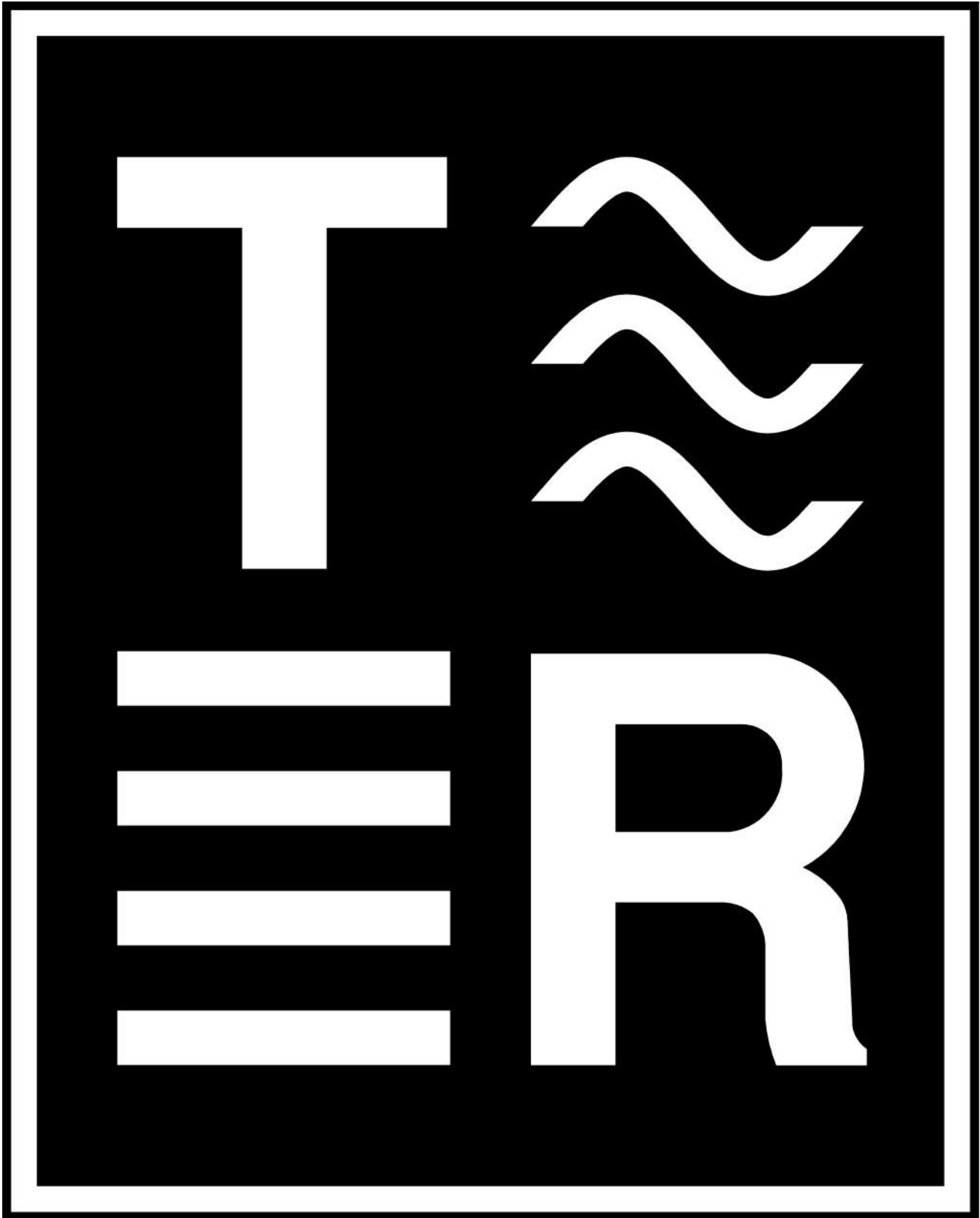

---

**T&R Test Equipment Ltd**

---

***TRUSTED & RELIABLE***

Our sister company Transformers and Rectifiers Ltd. have built an unrivalled wealth and depth of experience, key skills and design expertise over their 60-year history. The company has state-of-the-art in-house design, manufacturing and testing facilities at our premises in Guildford, UK.

Over the years, we have steadily expanded our product range so that, today, the company offers one of the widest ranges available in the world. We can cater for just about any power transformer and power rectifier application. We can design and develop innovative, bespoke solutions to even the most challenging customer requirements.



### Transformers

'Mineral' oil, 'Midel' fluid or 'Silicon' fluid filled transformers incorporating up to 7500 kVA, with a highest voltage of 36,000.



### Cast Resin

We can supply cast resin transformers for applications such as Rectifier, Converter, Traction and Distribution Transformers.



### Dry Type

Built to satisfy stringent requirements in terms of safety and reliability, and flexible to meet individual customer's needs.



### Rectifiers

A major core product in Transformers & Rectifiers Ltd's product range is the 'Transformer Rectifier Unit'.



### Stabilisers

We can offer stand-alone linear carbon roller regulators, or regulators forming part of a composite power supplies package.



### Regulators

We can offer stand-alone linear carbon roller regulators, or regulators forming part of a composite power supplies package.